

UNIVERSITY OF EDUCATION, WINNEBA

SOME ASPECTS OF NOMINALIZATION IN DAGBANI



MASTER OF PHILOSOPHY

2020

UNIVERSITY OF EDUCATION, WINNEBA

SOME ASPECTS OF NOMINALIZATION IN DAGBANI

MIFTAWU FUSEINI

(8170080010)



**A thesis in the Department of Applied Linguistics,
Faculty of Foreign Languages Education and Communication,
submitted to the School of Graduate Studies in partial fulfilment
of the requirement for the award of the degree of
Master of Philosophy
(Applied Linguistics)
in the University of Education, Winneba.**

JULY, 2020

DECLARATION

STUDENT'S DECLARATION

I, Miftawu Fuseini, hereby declare that this thesis, with the exception of quotations and references contained in published works which have all been identified and duly acknowledged, is entirely my own original work, and it has not been submitted, either in part or whole, for another degree elsewhere.

Signature.....

Date.....

SUPERVISORS' DECLARATION

We hereby declare that the preparation and presentation of this work was supervised in accordance with the guidelines for supervision of Thesis as laid down by the University of Education, Winneba.

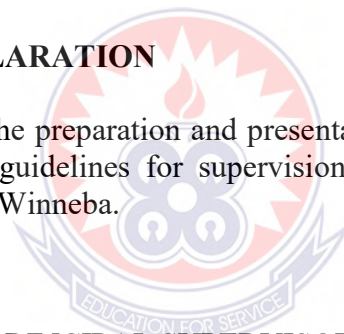

DR KWAKU OFORI (PRINCIPAL SUPERVISOR)

Signature.....

Date.....

DR. ROGERS KROBEA ASANTE (CO-SUPERVISOR)

Signature.....

Date.....

DEDICATION

To

Almighty Allah, the Giver of Life, Wisdom and Health,

My dear wife, Faustina Issah and our children Wunintira, Wuntuma and Nasara

&

My late father, Fuseini Iddi.



ACKNOWLEDGMENTS

First and foremost, my sincere and deepest gratitude and appreciation goes to the Almighty Allah who has continued to be my main source of encouragement and support when I feel that my human nature is failing me. He encouraged me to keep on working when I wanted to give up.

To my able supervisors, I would like to express my profound gratitude to Dr Kwaku Ofori and Dr Rogers Krobea Asante for their patience, words of encouragement and the love in guiding me throughout this journey. They have been my backbone and my life support.

Furthermore, my worm appreciation to all the Lecturers in the Applied Linguistics Department; Dr. Charlotte Fofu Lomotey, Professor Yusuff Ayodele Luqman, Dr Rebecca Akpanglo-Nartey. I equally want to thank the visiting Lecturers; Dr Amuzu Evershed, Dr Gorge Akanlig-Pare, and Dr Kwame Agbedor for their valuable contribution, support and love shown me during the coursework. May God richly bless you.

I also want to thank all the non-teaching staff of the Faculty of Foreign Languages and Communication and the Department of Applied Linguistics for their support. A special mention of appreciation goes to Madam Mary Dzidzorvu at the Department of Applied Linguistics for her motherly support.

I equally owe much to my Course mates and friends at the Department; Anane, Jacob, Joy, Ernestina, Ama-Serwah, Esther, Elizabeth, Bernard, Kwame and Yakubu.

Finally, my gratitude to the following people: Mr Adams Alhassan Stephen, Mr Mohammed Seini, Mohammed Osman Nindoo, Alhaji Andani Zakaria as well as the entire staff of Sorugu J.H.S for their contribution to this work.

TABLE OF CONTENTS

Contents	Pages
DECLARATION	iii
DEDICATION	iv
ACKNOWLEDGMENTS	v
TABLE OF CONTENTS	vi
LIST OF TABLES	x
LIST OF FIGURES	xii
LIST OF ABBREVIATION	xiii
ABSTRACT	xv
CHAPTER ONE : INTRODUCTION	1
1.0 Introduction	1
1.1 Background to the Study	1
1.2 The Dagbani Language and its Speakers	2
1.3 Dagbaj	4
1.4 Statement of the Problem	5
1.5 Purpose of the Study	6
1.6 Objectives of the Study	7
1.7 Research Questions	7
1.8 Significance of the Study	7
1.9 Delimitation of the Study	8
1.10 Limitation of the Study	8
1.11 Organization of the Study	8
1.12 Chapter Conclusion	10

CHAPTER TWO : LITERATURE REVIEW	11
2.0 Introduction	11
2.1 The Concept of Nominalization	11
2.2 Theoretical Framework: Basic Linguistic Theory	16
2.3 Theoretical Framework: Autosegmental Phonology (Goldsmith 1976)	18
2.4 Literature Review	20
2.5 Morphological processes of nominalization identified in Dagbani	50
2.5.1 Affixation	52
2.5.2 Compounding	53
2.5.3 Reduplication	54
2.6 Some Phonological Processes in Dagbani which are Relevant to this Study	55
2.6.1 Assimilatory Processes	55
2.6.2 Syllable Structure Processes	60
2.7 Chapter Conclusion	64
CHAPTER THREE : METHODOLOGY AND RESEARCH DESIGN	65
3.0 Introduction	65
3.1 Research Approach and Design	65
3.2 Data Types and Data Collection Procedures	67
3.3 Area of Study	67
3.4 The Study Population	68
3.5 Sample and Sampling Procedure	69
3.6.1 Elicitation	71
3.6.2 Focus group Discussions	72

3.6.3 Observation	73
3.6.4 Documents	74
3.6.5 Researcher's Native Intuition	74
3.7 Data Analysis Procedure	74
3.8 Accessibility	75
3.9 Ethical Consideration	76
CHAPTER FOUR : DATA PRESENTATION AND ANALYSIS	77
4.0 Introduction	77
4.1 Action Nominalization in Dagbani	78
4.1.1 Action Nominalization through Affixation	79
4.1.3 Action Nominals derive from inherent complement verbs through affixation	81
4.1.4 Syntactic functions of the Derived nominals	83
4.2 Abstract Nominalization in Dagbani	87
4.3 Agent (ive) Nominalization in Dagbani	91
4.3.1 Agentive Nominals derived from verb stems through Affixation	92
4.3.2 Agentive nominalization through reduplication	95
4.4 Patient Nominalization	106
4.4.1 Patient nominalization through compounding and affixation	106
4.4.2 Subject position	108
4.4.3 Object position	108
4.5 Location Nominalization in Dagbani	108
4.6 Experiencer Nominalization in Dagbani	110
4.7 Instrumental Nominalization	111

4.7.1 Instrumental Nominalization through Affixation in Dagbani	112
4.8 Result/ Product Nominalization	113
4.8.1 Syntactic functions of the result nominalization	116
4.9 Manner Nominalization	117
4.10 Autosegmental Phonology Representation of nominalization in Dagbani	118
4.10.1 Assimilation	118
4.10.2 Syllable structure processing	125
4.11 Chapter Conclusion	132
CHAPTER FIVE : SUMMARY OF THE STUDY, SUMMARY OF FINDINGS AND RECOMMENDATIONS	133
5.0 Introduction	133
5.1 Summary of the Study	133
5.2 Summary of Findings	135
5.3 Recommendations	137
REFERENCES	138
APPENDIX : Some Nominalized Forms In Dagbani	143



LIST OF TABLES

Table	Page
1: Verb-suffix action nominals in Dagbani	79
2: Reduplicated derive action nominals	80
3: Verb-Noun+ Suffix derived action nominals in Dagbani	82
4: Verb-Suffix abstract nominals in Dagbani	88
5: Verb-suffix abstract nominals in Dagbani	88
6: Verb-Suffix abstract nominals in Dagbani	89
7: Verb –Suffix derive Abstract Nominals in Dagbani	90
8: Verb-Suffix derive Abstract nominals in Dagbani	91
9: Verb-suffix derived agentive nominals in Dagbani	92
10: Verb-suffix derived agentive nominals in Dagbani	93
11: Verb-Suffix derived agentive nominals in Dagbani	93
12: Noun-suffix derived agentive nominals in Dagbani	95
13: Noun reduplicated derive agentive nominals in Dagbani	96
14: Noun-Noun Compound Agentive Nominals in Dagbani	97
15: Verb-Noun Compound-Suffix derive agentive nominals in Dagbani	99
16: Nouns-Verb + Suffix derive agentive nominals in Dagbani	101
17: Agentive nominals derived from (ICVs) through affixation	102
18: Derived agentive nominals from (ICVs) through affixation	104
19: Noun-Verb-suffix Compound Patient Nominals	107
20: Verb-Suffix derive Location Nominals in Dagbani	109
21: Verb-Suffix derive experiencer nominals in Dagbani	110
22: Verb-Suffix derive Instrument Nominals in Dagbani	112
23: Verb-Suffix derive Product Nominals in Dagbani	113

24: Verb-Suffix derive Product Nominals in Dagbani	114
25: Verb-Suffix derived Product nominals in Dagbani	115
26: Verb-Suffix derived Product nominals in Dagbani	115
27: Noun-Suffix derive Result/ Product Nominals in Dagbani	116
28: Verb-Suffix derive Manner Nominals in Dagbani	117



LIST OF FIGURES

Figure	Page
1: Language Map of Ghana:	68



LIST OF ABBREVIATION

1	First person
2	Second person
3	Third person
AG	Agentive
ANIM	Animate
CONJ	Conjunction
DEF	Definiteness marker
DEM	Demonstrative
DET	Determiner
FOC	Focus
FUT	Future
IMPERF	Imperfective
INDEF	Indefiniteness
INST.PL	Instrumental plural
INST	Instrument
LOC	Location
N	Noun
NEG	Negative
NOM	Nominal
NUM	Number
NZL.PL	Nominalizer plural
NZL.SG	Nominalizer singular
NZL	Nominalizer
OBJ	Object



PAT. NOM	Patient nominal
PAT. NZL	Patient nominalizer
PERF	Perfective maker
PL	Plural
POSS	Possessive
PRO	Pronoun
PROG	Progressive
PRST	Present
PST	Past
RED	Reduplicated form
SG	Singular
STAT	Stative
SUBJ	Subject
SUFF	Suffix
V	Verb
VP	Verb phrase
DEI	Deictic

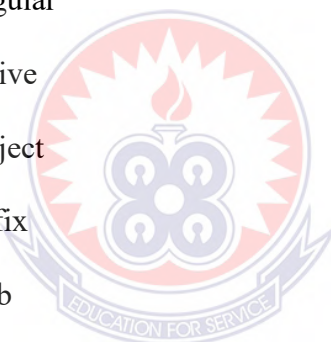

ABSTRACT

The primary aim of this thesis was to investigate some aspects of nominalization as it operates in Dagbani, a Gur language widely spoken in the Northern region of Ghana. The Basic Linguistic Theory (BLT) (cf. Dixon, 2009, 2010 & 2012) and Autosegmental phonology (Goldsmith, 1976) were adopted for this study. The study explores the types, morphological as well as the phonological processes of nominalization in Dagbani. It further examines the syntactic properties that the derived nominal shares with a prototypical Dagbani noun or noun phrase. Nominalization is the process of deriving nominals from a combination of other lexical categories or phrasal entities (Adeniyi, 2010, p.5). Languages of the world adopt one or more strategies for deriving nominals from verbs, adjectives or other nouns (Comrie & Thompson, 2007, p.335). It is revealed in the study that Dagbani employs one mechanism (morphological) in deriving nouns from other word classes. This mechanism or strategy involves affixation, compounding and reduplication. The study also revealed that just like other languages in Ghana, the derived nominals in Dagbani also possess some syntactic properties of a prototypical noun. For instance, it can function as a subject, occur in the object position and can be focused in a clause. It further explores some phonological issues in the study as far as nominalization in Dagbani is concerned. The study applied semi structured interview, observation, focus group discussion and native speaker's intuition using a qualitative approach. The participants used for the study were purposively selected from both educated and uneducated native speakers of Dagbani. The study was to answer research questions about the types and processes of nominalization. The types identified in the study are ones denoting Action, Actor (agentive), Location, Abstract (ive), Manner, Result and Experiencer. Phonological processes such as vowel harmony, homorganic nasal assimilation, epenthesis and elision were examined. Finally, in relation to Agent nominalization, the study revealed that, the suffixes, **-da** and **-ra** are also used for Patient and Experiencer nominalizations.

CHAPTER ONE

INTRODUCTION

1.0 Introduction

This thesis aims at exploring the processes by which nouns are formed and the product of these processes in Dagbani. This thesis set out to discuss some aspects of nominalization in Dagbani, a Gur-language in northern Ghana. It aims at contributing to the understanding of the morphology, syntax and the phonology of Dagbani as far as nominalization is concerned using the Basic Linguistic Theory (Dixon, 2009, 2010, 2012) and Autosegmental phonology (Goldsmith, 1976). It discusses the various types of nominalization, the linguistic processes (morphological & phonological) that take place as well as the syntactic functions that exist in deriving nominals in Dagbani.

Thus far, the current chapter is the general introduction to the thesis. In view of this, I present the general background to the study in section 1.1. This is followed with a brief discussion in Dagbani and its speakers as well as the sociolinguistic description in sections 1.2 and 1.3 respectively. Also, the problem statement is presented in section 1.4 which is followed by the purpose of the study in section 1.5. In the sections 1.6 and 1.7 present the objectives of the thesis and the research questions respectively. Section 1.8 highlights the significance of the study. In sections 1.9 and 1.10 the delimitation and limitation of the study are presented respectively. Finally, section 1.11 shows how the chapters are organized whilst section 1.12 concludes the discussion in the chapter.

1.1 Background to the Study

Wang (2010, p.9) opines that nominalization is the “process whereby a verb or an adjective is converted into a nominal group.” As Payne (1997, p.225) also posits that

nominalization is the “process by which an action nominal is formed from a non-action nominal.” Although, this definition from Payne is limited to only action nominals, it is possible to derive other types of nouns from action verbs, non-action verbs, adjectives and other nouns in Dagbani. This observation makes the study of nominalization an interesting topic worthy of investigation in many languages including Dagbani. Nominalization is a widespread phenomenon in the study of the grammar of languages. The nominalized form just like the prototypical nouns, function as subject, direct object or indirect object or possessum in a possessive construction within the sentence structure.

Generally, in the study of nominalization, there are different strategies that languages employ to form nouns. These strategies according to Payne (1997, p.226) are Phonological, Syntactic, Analytical and Morphological strategies. At least, some languages may employ one or two strategies listed above to derive nominals. This current study investigates nominal derivation in Dagbani. The study of nominalization helps students to be aware of the grammatical complexity of language and how the language works to pack meanings in sentence (Vinh et al 2013).

1.2 The Dagbani Language and its Speakers

Dagbani is a Gur language spoken in the north-eastern part of Ghana by Dagbamba (Dagomba). The native speakers know themselves as Dagbamba (Dagbana, singular). Non-native speakers of Dagbani refer to the people as Dagombas. Dagbani has Dagban as its state. It genetically belongs to the Niger-Congo language group (Hudu, 2010; Bendor-Samuel, 1989; Naden, 1989, 1988). Dagbani is also classified as a member of the Moore Gurma sub-group of West African languages. (Naden, 1989; Wilson, 1970; Greenberg, 1963). Bodom (1993) proposes the term **mabia** (my

mother's child) for the group of languages within which Dagbani is part. This shows that the languages are related to one another in one way or the other. These include; Kussal, Dagaare, Dagbani, Mampurili, Talen, Moore and Safaleba.

Genetically, Dagbani is zoned into two groups marked with a particular variant of Dagbani called a dialect. For example, those speakers from the western Dagbani use the Tomosili while those from the eastern zone are identified with the Nayahili variant (Wilson, 1970). This assertion contradicts Abdul-Rahaman (2007) and Hudu (2010) view about the fact that Dagbani constitutes three dialects namely; Tomosili, Nayahili and Nanuni. I hold a similar view to that assertion since these three dialects are mutually intelligible.

The Western dialect (also known as Tomosili) is spoken in Tamale the largest city in northern Ghana and the administrative capital of Dagbamba and its surrounding towns and villages. The Eastern dialect (Nayahili) is spoken in Yendi, the traditional capital of the Dagbamba ethnic group. The third dialect, Nanuni, is spoken in Bimbila and its surrounding towns and villages. The traditional and administrative capital of the Nanuni speakers is Bimbila. Dialectal differences between these three major dialects are mainly at the phonological and lexical levels.

Gurundoo (2012) proposes *Ɔmamprili* (Mampurili) as the fourth dialect in addition to three dialects mentioned earlier. Gurundoo regards *Ɔmamprili* as a dialect of Dagbani but not as a language as perceived by some scholars. He argues that given the high intelligibility rate between the Nayahili and Tomosili as observed by Naden (1989), *Ɔmamprili* cannot be a language on its own. Dagbani is spoken on both national radio and television, and also taught as a subject /course in schools from basic to tertiary

level. A great number of Dagbamba are Muslims and a small number being Christians and few being Traditionalists (Oppong, 1973).

1.3 Dagbaŋ

The traditional state of Dagbaŋ covers an area of about eight thousand square miles of the northern region of Ghana. It lies between latitude 9 °N and 10 °N. It stretches its length across Kubalim in the South East of Zabzugu District to Zantaani in the North West of Tolon District, with total distance of about 322km and width is about 161km (Mahama, 2004 & Oppong, 1973). Dagbaŋ has ten (10) administrative capitals. Out of this number, seven are district capitals, two municipal and one metropolitan which is Tamale. The main towns in Dagbaŋ are Tamale, Yendi, Savulugu, Sagnarigu, Gushegu, Zabzugu, Karaga, Cheriponi, Tolon, Kumbugu, Saŋ, Saboba, Nanton, Tatali Saambu, Diary, Kpatinga as well as Sunsoŋ among others. It shares boundaries with a highly mutual intelligible dialect Nanuni in the south-east, in the south-west it shares boundary with Gonjas (now Savana region), north-east with Moar and Konkombas and in the northern part it shares boundary with Mamprusi (North East region) (Mahama, 2004 & Oppong, 1973).

Dagbaŋ has trees of economic importance. Among these, common trees in the area the Shea tree, Dawadawa, Baobab, Kapok and Mango. Traditionally the Dgbamba are subsistence farmers depended so much on their livestock and crops for food and income. Dagbaŋ is noted to be one of the food baskets of Ghana but a reasonable number of them are peasant farmers and a few are commercial farmers. The main crops they cultivate are cassava, maize, yams, rice, groundnut, millet, guinea cone, soya bean, mango, shea nut, cashew, and vegetables. They also rear animals and birds like cattle, goat, sheep, fowls, guinea fowl, turkey, dove and few others are fishers.

1.4 Statement of the Problem

Nominalization is believed to be one of the most important resources and powerful structures of creating a lexically dense style via building long noun phrases which differentiates spoken and written discourses. This density can also be the result of the “process of syntactic reduction” which helps to construct texts economically (Fowler, Hodge, Kress, & Trew, 1979, p.41). Nominalization also helps create textual cohesion and remove human participants and make the text more objective (Mueller, 2015 & Baratta, 2010). This latter use of nominalization occurs via removing the responsibility from a human participant and hence objectifying the process (Kazemian & Hashemi, 2014).

Based on the word origin, morphological structure and the function in the grammatical structure of the clause, nominalization has been classified into different types. Accordingly, different researchers represent various categorizations of nominalizations (see Rodby & Winterowd, 2005; Carolyn, 2004; Hartnett, 1998).

Nominalization as a means of packaging information is of abundant use both in written and spoken scientific discourse. However, the written mode lends itself better to the application of nominalization due to its very nature.

In Dagbani, there are several nominal suffixes used in the formation of nouns from other lexical categories. These nominal suffixes may also perform some dual functions as, pre and post verbal particles. The challenge may be resolved through semantic and morphosyntactic relation of the derived nominals. The nominalized forms belong to a certain domain. Some of these have received some attention especially the pre and post verbal particles as well as few of the nominal suffixes and

their semantic relations in the language. (See Gurundoo, 2014; Issah, 2013, 2008; Adam, 2007; Abdul-Rahaman, 2007; Olawsky, 1999 & Abu-Bakari, 1988).

However, this is not exhaustive looking at the strategies, processes and the functions of nominalization in Dagbani. The problem is that there is no study that provides a detailed description to nominalization in Dagbani. This thesis seeks to examine the strategies Dagbani employs in deriving nominals, identify the linguistic processes of nominalization as well as to identify semantic relations and syntactic functions of the nominalized forms in Dagbani.

It is based on these reasons that I decided to investigate into some aspects of nominalization in Dagbani to fill this linguistic gap and to a large extent contribute to the linguistic knowledge. It also aims at contributing knowledge to the already existing scanty literature on the language. The nominalization aspects the researcher worked on include processes such as affixation, compounding, reduplication, nominalization types, some linguistic properties (morphology & phonology) as well as the syntactic functions of the derived nominals.

1.5 Purpose of the Study

The purpose of the study was to find out some aspects of nominalization in Dagbani. It looked at the various types and processes that the language employed to form nouns. The research also looked at the functions of the nominal within the sentence structure. The research also accounted for some phonological processes identified in the data within the Autosegmental theory.

1.6 Objectives of the Study

The aim of the study is to provide a comprehensive study on some aspects of nominalization in Dagbani. The study is guided by the following specific objectives:

1. To identify the types of nominalization in Dagbani.
2. To identify the linguistic processes used to derive the nominals in Dagbani.
3. To examine the functions of the derived nominals in Dagbani.

1.7 Research Questions

This study answers the following three questions on nominalization in Dagbani:

1. What are the types of nominalization in Dagbani?
2. What are the linguistic processes used to derive the nominals in Dagbani?
3. What are the functions of the derived nominals in Dagbani?

1.8 Significance of the Study

After this study has been completed, the findings will be significant in many ways: It will add to the little existing literature on the Dagbani (morphology, syntax and semantics). The study will also broaden the horizon of fellow researchers and pave way for them to research into other areas that the researcher will not be able to cover. It will also be useful to the general public particularly those who wish to study the grammar of Dagbani.

Furthermore, the study will also serve as a reference point to teachers and students on nominalization in Dagbani. Finally, the study would be useful to Dagbani language curriculum specialists.

1.9 Delimitation of the Study

The study was centered on nominal derivation which focuses on processes involved in nominalization and nominalization types. It also identified and discussed strategies involved deriving verbal nominal or deriving nouns from another noun as well as some linguistic properties such as morphology, phonology, syntax and semantics.

The language in which the observed phenomenon occur for the study is Dagbani, the native language spoken in Dagbaŋ. The study was carried out in Gushegu and Yendi with participants constituting students and teachers at the Junior and Senior High schools in the research area. There were also some university students and other elderly native speakers of Dagbani. There was a high level of cooperation between the respondents and the researcher during the data collection.

1.10 Limitation of the Study

As far as limitation for this study is concerned, a study of this nature cannot be free from challenges. The researcher encountered some difficulties during the data gathering for the study. The researcher lived in tamale but sometimes, he had to travel to Yendi and Gushegu to collect the data.

In mitigating this development, the researcher had to rely on the two research assistants he engaged and sometimes through phone calls to the respondents for some clarification. In spite of the challenges mentioned above, the study was successfully done.

1.11 Organization of the Study

This study presents some aspects of nominalization in Dagbani, an Oti-Volta language that belongs to the Gur family of languages spoken in the northern region of Ghana.

The study is divided into five chapters. In chapter one, which is the introductory part, covered a general introduction to the study, Dagbani and its speakers, background to the study, the research problem and objectives of the study. The research questions, significance of the study, limitations/delimitations and finally organization of the study were also discussed.

In the second chapter, it concentrated on related literature review. It reviewed relevant literature to the study which included literature on Dagbani, some other Gur and Kwa languages in Ghana and literature on other languages worldwide. The chapter also discussed the theoretical frameworks, some morphological, phonological processes relevant to the study.

In chapter three, the research methodology and design were discussed. Here, the various methods that were employed to gather the data for this study were discussed and analyzed. The chapter looks at the research design, populations, sampling techniques and sample size. I also presented the data collection instruments, data analysis and data presentation.

Chapter four dealt with analysis of the Dagbani nominal derivation, nominal affixes, and types of nominalization as well strategies for forming the nominals including the functions of the derived nominals as well as some phonological processes in deriving nouns.

Chapter five ends the discussion of the study with summary of findings, recommendations and concluding remarks for further research followed by references.

1.12 Chapter Conclusion

This chapter has presented the general introduction to the study. The chapter discussed aspects of nominalization in Dagbani, a Gur language spoken in the Northern Region of Ghana. The chapter discussed the background to the study. The chapter also highlighted some linguistic information about the Dagbamba people and their language. In addition to these, the chapter also presented the statement of the problem, purpose of the study, objectives of the study, the research questions, limitation and delimitations of the study, significance of the study as well as the organization of the study.



CHAPTER TWO

LITERATURE REVIEW

2.0 Introduction

This chapter examines some aspects of nominalization in Dagbani. It seeks to look at the general strategies Dagbani employs to form the nominals. To expand this, the chapter looks at the types and linguistic (morphological and phonological) processes involved in deriving nouns as well as examine the syntactic functions of the derived nominals in the language. To achieve these objectives, the chapter reviews the existing literature related to the current study. The chapter also presents the theoretical frameworks that the researcher adopted to provide comprehensive analyses to the data obtained. The chapter is segmented into six sections. Section 2.1 highlights the concept of nominalization in various languages. Sections 2.2 and 2.3 discussed the two theoretical frameworks adopted in the study. These are; the Basic Linguistic Theory and the Autosegmental Phonology. In section 2.4, some empirical studies on nominalization in some languages are discussed. Section 2.5 presents a discussion on the morphological processes identified in nominalization. In section 2.6, the chapter presents a discussion on some phonological processes that are observable in deriving nominals. The chapter conclusion is provided in section 2.7.

2.1 The Concept of Nominalization

Nominalization has been defined by different scholars in different terms. For Richards et al. (1985, p.126) “nominalization is a word transformation such as verbs or adjectives transformed into nominal class of words.” Wang (2010, p.9) also opines that nominalization is the “process whereby a verb or an adjective is converted into a nominal group”, while Payne (1997, p.225) avers that nominalization is the “process by which an action nominal is formed from a non-action nominal.” All these

definitions as well as other definitions claim existence of nominalization in natural languages. The study of nominalization has attracted many linguists around the world. Nominalization as such plays very important role in enriching lexical nouns. All languages globally have nouns formed from some process but they may have different ways of deriving nominals. In the concept of nominalization, the types of nominalization, strategies, some derivational strategies (processes), the lexical categories employed as well as the functions of the derived nominal were investigated. For example, the linguistic expression from which the nominal is derived may be a word, a phrase or even a clause, as illustrated in (1), (2) and (3) respectively.

(1) Deriving a nominal from a word

(swim → swimming)

- | | | |
|------|---------------------------------|------|
| (a). | Benedicta can swim. | Verb |
| (b). | Swimming is a form of exercise. | Noun |
| | (dance → dance) | |
| (c). | Neendoo can dance Damba | Verb |
| (d). | Hidaya has gone for a dance. | Noun |

(2) Deriving nominals from a phrase (Akan: Appah, 2003, p.108)

- | | | |
|------|----------------------|---------------------|
| (a). | asɛm papa | asɛmpa |
| | a good matter | ‘Gospel’ |
| (b). | adze dɔkɔdɔkɔ | adɔkɔdɔkɔdze |
| | a sweet thing | ‘sweets’ |
| (c). | aboa funu | aboafun |
| | ‘a dead animal’ | ‘carcass’ |

(3) Deriving a nominal from a clause

Sɛ manhyia	Semanhyia
‘if I had not met’	‘a place name’

Just as verbs are known to be the commonest and most viable source for nominalization, they may also be formed from other word classes such as adjectives and other nouns, as (4) and (5) illustrate respectively.

(4) Deriving nominals from adjectives

- | | | |
|------|-----------------------|---------------------------|
| (a). | sɔglaa ‘black’ | sɔglɔŋ ‘blackness’ |
| (b). | paalaa ‘new’ | paalɔŋ ‘newness’ |

(These data were taken from Dagaare; Bodomu, 1997, p.17)

(5) Deriving nominals from nouns Nkami

- | | | |
|------|----------------------|-----------------------------|
| (a). | kua ‘farm’ | kuani ‘farmer’ |
| (b). | sika ‘money’ | sikani ‘rich person’ |
| (c). | China ‘China’ | Chinani ‘Chinese’ |

(These data were taken from Asante, 2018, p.12)

It is generally observed that nominals are derived basically through; lexical, phonological/prosody, analytical as well as morphological strategies. These are the major strategies that some languages employ to form nominals from verbs. For example, English employs the first two strategies, as illustrated in (6).

- (6) a). Azumah can fight Mike.
 b). Bukum had a good fight last week.

As it is observed in (6) above, it is generally agreed that in English “fight” in (6b) functions as a noun whilst “fight” in (6a) functions as a verb. The strategy for the derivation of the noun “fight” in (6b) is lexical because it employs ‘zero’ marking; that is, the change from verb to noun is not signaled by any structural change in the

word. Therefore, the form of the verb does not undergo any change during the derivation.

Fante, a dialect of Akan, also employs the second strategy, that is a prosodic/phonological strategy in (7), where the derivation of the nominal **nántéw** ‘walking’ (7b) from the verb **nàntéw** ‘walk’ (7a) is based on how the two forms are produced: whilst the former is produced with a LH tonal pattern, the latter is produced with a HH pattern.

(7) Fante (Appah, 2003, p.84)

a. **Kofi nántéw ntɛ.ntɛm** (Verb)

Kofi walks RED.quickly

‘Kofi walks very fast.’

b. **Kofi nántéw yɛ ntɛntɛm** (Noun)

Kofi walking be RED.quickly

‘Kofi’s (manner of) walking is very fast.’

Ofori (2013, p.75) indicated that action nominalization in Anum involves tonal changes on the tonal pattern of the verb root which serves as the imperative and uninflected form of the verb. These are exemplified below;

(8) a. **fòkyí** ‘sweep’ **ɔ́fókyì** ‘sweeping’

b. **bìlì** ‘speak’ **m̀bìlì** ‘speaking’

It could be seen from the examples above that whereas the imperative forms take a low-high tone pattern, the nominals take a high-low tone pattern. This phenomenon is similar to what pertains in Letɛ, a related Guan language (cf. Akofi-Ansah, 2012, p.7). According to (Li & Thompson, 1981, p.33) nominalizations may also “be analytic in languages which employ periphrastic means to form nominals.” For example,

Mandarin Chinese is known to be rich in using this strategy. It uses the particle **de** to form various types of nominalizations, as (9) exemplifies (Payne, 1997, p. 225).

- (9) **women hézuò de wèntí ěn jiǎndǎn**
 We cooperate NOM problem very simple
 ‘The problem concerning our cooperation is very simple.’

In (9) the action nominal cooperation is derived from the verb, **hézuò** ‘cooperate’, through the use of the analytic nominalizer **de**. The fourth strategy (morphological), is achieved through some modification in the verb. Different types of affixes come into combination with the verb stem in deriving the nominals. They might be prefixed, suffixed or circumfixed as illustrated in example (10) below;

- (10) a. Tina loves to swim in the school pool.
 b. Swimming is a form of exercise.
 c. (i) **ba** ‘steal’ (Verb) **kuba** ‘stealing’ (Noun)
 (ii) **ku-ba si-kwa-bwino**
 NOM-steal NEG-of-good
 ‘Stealing is not good’
 (iii) **ku-seka** ‘laugh’ **kuseka** ‘laughing’
 (iv) **ku-seka kwa-ndi-pweteketsa mmimba.**
 NOM-laugh has-1SG-pain stomach
 ‘Laughing has caused me to have stomach-ache’
 (Data in 10c taken from Chechewa; Matanda, 2004, p.15)

As seen in the above example, the noun swimming in (10b) is derived from the verb swim in (10a). The strategy for the derivation of the noun swimming in (10b) is morphological because there is a structural change signaled by the -ing suffix in the derivation of ‘swimming.’ Therefore, the derivation of the noun ‘swimming’ from the

verb swim employs a morphological strategy in English language. Also, example (10c) above shows how Chechewa employs the morphological to derive nouns from verbs. Therefore, there is structural change by attaching the **ku-** prefix to the verbs to derive **kuseba** ('stealing') and **kuseka** ('laughing') in (10c i & 10c iv) respectively. As we shall observe in chapter 4, Dagbani employs only the morphological strategy in nominalization.

2.2 Theoretical Framework: Basic Linguistic Theory

The main theoretical framework adopted in this study is the basic linguistic theory BLT proposed by (Dixon, 2009, 2010, 2012). As a theoretical concept, as indicated by Dryer (2006, p.211), "the BLT is a cumulative typological framework in nature that employs mainly the techniques of analysis derived from the traditional grammar and increasingly accepts the influence from other theoretical models developed over years." The Basic Linguistic Theory also accepts the influence from other theoretical models and considers the relevant aspects of both old and new traditions. The BLT has received many reviews and attractions from different linguists and scholars in their research works because of its unique approach to language study. Dryer (2006; Ofori, 2013, p.14) describes that the "BLT differs most sharply from other contemporary theoretical frameworks in what might be as its conservativeness."

Dryer (2006, p.211; Asante, 2016, p.24) also posits that "unlike many theoretical frameworks that assume previous ideas only to a limited extent and freely assume many novel concepts, basic linguistic theory takes as much as possible from earlier traditions and only as much as necessary from new traditions." It can thus be roughly described as traditional grammar, minus its bad features (such as a tendency to describe all languages in terms of concepts motivated for European languages), plus necessary concepts absent from traditional grammar. It had supplemented traditional

grammar with a variety of ideas from structuralism, generative grammar (especially pre- 1975 generative grammar and relational grammar) and typology.

Asante (2016, p.24) indicates that “the goal of the basic linguistic theory is to allow the genius of the language to evolve.” The BLT therefore places much emphasis on observational, descriptive and explanatory adequacy, rather than reinterpretation of facts to study why a particular language behaves the way it is.

Asante (2016) adopts the BLT in the study of Nkami grammar because of the apparent simplicity of the BLT. The theory allows Nkami to tell its own story so that this grammar is comprehensive, accurate, comprehensible, accessible, and comparable and long-lasting since every language is unique.

For Ofori (2013, p.14), using BLT theory will help provide an adequate description of the Anum language using suitable analysis and arguments on how the language is used, taking note of how context and situation contribute to give the particular sense that the people share. The theory also supports the conscious effort in explaining every grammatical point discussed using terminology and abbreviations that will not be beyond the comprehension of the linguist and the interested reader.

Ziblim (2018) also used this framework because it assisted him to describe into details and offer adequate explanations of the morpho-syntax of the Dagbani nominal phrase. This all-embracing theory will help me provide an adequate and comprehensive description of some of the aspects of nominalization in Dagbani drawing data from the Nayahili dialect of Dagbani.

2.3 Theoretical Framework: Autosegmental Phonology (Goldsmith 1976)

Additionally, Basic Linguistic Theory accepts the influence from other theoretical models. For this reason, the framework of Autosegmental Phonology as propounded by Goldsmith (1976) and Kenstowicz (1994) was used to account for some phonological processes such as homorganic nasal assimilation, vowel harmony, elision as well as epenthesis (See Atipoka & Nsoh, 2018; Musah, 2010; Durand, 1990).

Autosegmental phonology (Goldsmith, 1976) began as a theory of tone in which tones are not regarded as features of vowels but as separate, autonomous units that have a separate level, or tier of representation, which are related to segments by rules of association. According to Kenstowicz (2006), in this theory, there are conditions governing a well-formed association of tones and vowels such as one-to-one mapping and from left- to-right without associated tones or vowels deriving the surface patterns by simple rules operating in local environments. Instead, tone stability occurs; since tones are autonomous, when a vowel is deleted, the tone persists on its own tier and maps to an adjacent syllable to ensure maximal association.

Phenomena such as stress, the syllable, vowel harmony (Clements, 1976) and nasalization, which could not be represented in Standard Phonetic of English (SPE) were addressed in generative phonology in order that phonological processes could be expressed in Autosegmental terms (Hyman, 1982; The Routledge Linguistics Encyclopedia, 2010; Clements & Keyser, 1983). Hence, vowel harmony, which involves two vowels showing agreement in the values for a particular feature can be represented within this theory of Autosegmental phonology using feature spreading. For instance, using the feature [ATR] within the domain of a word in a language, all vowels in a word must have the same value for a particular feature [\pm ATR] (Ewen

&Van der Hulst, 2001, p.46; Atipoka & Nsoh, 2018, p.12). For non-linearity, Goldsmith (1976) proposed that phonological representations should be composed of multiple tiers of segments, which correspond to the different gestures of speech and differ according to the features that are specified for the segments on them. So that, different features may be placed on separate tiers. Hence, three tiers/levels of representation linked by association lines are employed as follows;

-The feature tier (harmonic tier), which is represented as ATR

-The skeletal tier: it is represented as X - the intermediate tier that links segments on the feature tier to segments on the segmental tier.

-Place / Manner of Articulation Tier (P. A. /M. A. Tier): This tier specifies the Place or Manner of articulation features of the segment that are significant to the phonological analysis. This applies in the formalization of phonological processes such as Homorganic Nasal Assimilation, Labialization and Glide formation.

-Tongue Root/Lip Rounding Tier: This tier spells out the tongue root and lip rounding position features of the phonological segments whether it is an Advanced Tongue Root feature (+ATR) or Unadvanced Tongue Root feature (-ATR) or whether it is a Rounding feature (+Round) or Unrounding feature (-Rounding). This tier is very relevant in the discussion of Vowel Harmony as a phonological process in Dagbani.

-Syllable Tier: This tier indicates the units of sounds that make up a word. It is applicable in the discussion of the syllable type in Dagbani and syllable structure processes such as elision, epenthesis, linking, and segment deletion. The CV-tier model of the syllable structure is used in this thesis.

-The segment tier is represented as Sec - features are assigned to segments by association lines. Based on the well-formedness condition for Vowel harmony, all vowels are associated with the harmonic feature with lines that link segments on the feature tier to segments on the segmental tier (association lines) defined as follows;

-A solid association line indicates pre-linking.

-A broken association line indicates active linking (by means of spreading).

-A crossed-through association line shows delinking or disassociation

-Brackets show the boundaries of a phonological form.

In the Autosegmental representations, assimilation is represented by spreading a feature from one anchor to another, represented by a broken association line. (See; Atipoka & Nsoh, 2018; Ofori, 2013; Musah, 2010; Akanlig-Pare, 1999).

2.4 Literature Review

This section of the chapter discusses works in relation to the present study. The literature is reviewed on some aspects of nominalization in Dagbani in general and taking into account, the strategies, the morphosyntactic and semantic roles that exist in deriving nouns from other lexical categories. It also discusses some phonological issues in nominal derivation in Dagbani. Not only that, processes involved in forming nominal such as affixation, compounding and reduplication are discussed.

Bomanchihi (2012) treated nominal derivation in word formation processes in Dagaare. According to Bomanchihi (2012, p.34), nominal derivation is the result of forming nouns from verbs, adjectives and other nouns, phrases or clauses. According to her, three processes are involved in nominalization. These include the nominalization of verbs, adjectives and nouns. She indicates that in nominalizing verbs, the process involves the addition of suffixes such as **-re**, **-bu**, **-bu**, **-mo**, **-bu** to

the verbs. She adds that the suffix **-rɛ**, which is an agentive, is added to the duplicated form of the verb to realize the nominal whereas the rest of the affixes are attached to the infinitive form of the verbs. The examples below show nominalization of verbs, adjectives and nouns in Dagaare.

(11)	Verb	Gloss	Nominalized Item	Gloss
(a).	sɪɛ	‘dance’	sɪɛsɪɛrɛ	‘dancer’
(b).	mɛ	‘build’	mɛmɛrɛ	‘builder’
(c).	wuo	‘weave’	wuowouro	‘weaver’

(12).	Verb	Nominalized Item
(a).	sɪɛ ‘dance’	sɪɛbu ‘act of dancing’
(b).	ŋme ‘beat’	ŋmebu ‘act of beating’
(c).	mi ‘rain’	miibu ‘act of raining’
(d).	lee ‘fall’	leebu ‘act of falling’

(13).	Adjective	Nominalized Item
(a).	sɔglaa ‘black’	sɔglɔŋ ‘blackness’
(b).	paalaa ‘new’	paalɔŋ ‘newness’
(c).	baalaa ‘soft’	baalɔŋ ‘softness’
(d).	faa ‘bad’	faalɔŋ ‘bad deed/evil’

Bomanchihi’s work is relevant to the current research in that the current research seeks to also investigate the process of forming nouns from other lexical categories, the phonological processes that are likely to occur when nouns are formed, as well as some functions of the derived nominal in Dagbani. The previous work investigates

some word formation processes which in part looks at nominalization in Dagaare while the current study examines some aspects of nominalization in Dagbani but both languages are Gur languages and therefore, they share some substantial common grammatical features.

Dakubu (2005) discusses Dagaare nominal structures. She posits that every nominal has a root that never occurs on its own, but has a number suffix or is compounded with another following lexical item. She indicates that a basic nominal consists of a root plus an affix usually a suffix that shows singularity or plurality. She again postulates that Dagaare can have roots that exist on their own without the number suffix. The example (14) below illustrates her assertion.

(14)	SINGULAR	PLURAL
(a).	zu ‘head’	zuri ‘heads.’
(b).	ba ‘friend’	bamine ‘friends’

The example above shows the words are the roots as well as the singular form. It is only when the affixes are attached to them that the plural forms are realized. Discussing abstract nouns in Dagaare, Dakubu (2005) posits that abstract nouns that name activities are derived from verbs by the suffix **-bu**, with the ‘b’ usually elided. She then provided the data below to back her point.

(15)	Verb	Nominalized item
(a).	di ‘eat’	diiu ‘eating’
(b).	kɔ ‘farm’	kɔɔɔ ‘farming’

Dakubu (2005) also includes agentive and instrumental nouns in her study. She argues that agentive and instrumental nouns are nouns which indicate the doer of an action, or an entity used to perform the action respectively. She offers explanation that if the

derived noun refers to a human agent, it sometimes adds the singular suffix of the gender and the plural formed with the gender plural suffix **-ba**. The data below were then provided.

(16)	SINGULAR	PLURAL
	(a). kɔɔr-a ‘famer’	kɔɔre-ba ‘farmers’
	(b). duor-o ‘climber’	duori-bo ‘climbers’

Just like Dagaare, Dagbani also derives agentive nominals by adding different agentive suffixes to the verb root. These include **-da**, **-ra**, **-na**, etc by the means of affixation, reduplication and compounding. The work is relevant to the current research. Whilst the current research investigates some nominal derivation processes, her work focuses on derivation.

In discussing word formation process in Dagbani, Adam (2007) looks at a derivational process where compounding, affixation, reduplication, borrowing and other word formation processes were discussed descriptively. He outlines the possible ways of deriving a new word in Dagbani by the use of affixes. He reveals that the root of a noun, adjective and verb could be extended through derivational processes, and that a verb could only be derived from verb and an adjective could also be derived from some verbs. He also indicates that a noun on the other hand could also be derived from a verb, adjective and another noun. He however indicates that not all lexical items in the language come together to form compounds and that verbs, nouns and adjectives are the only lexical items in the language that can come together to form compounds. Adam (2007) further looks at other morphological processes that are employed in Dagbani which do not require derivational affixes. These processes include borrowing, coinage and semantic shift.

Although, both works work on the same language (Dagbani), but the previous work focuses on word formation in Dagbani whilst this current study looks at some aspects of nominalization in Dagbani. The work is relevant to the current research as the current research investigates some aspects of nominalization in Dagbani and poses affixation as one of the most productive ways of bringing into Dagbani new words.

Mahama (2003) and Blench (2004) compiled Dagbani-English dictionary to enhance the language study. The above studies only focus was on the dictionary of Dagbani. English words were translated into Dagbani.

Abu-Bakari (1988, p.68) gives a comprehensive account of Dagbani word classes, assuming a close correspondence between both morphology and syntax and provides a brief analysis of nominalization in Dagbani. On the nominalization of Dagbani, Abu-Bakari (1988, p.68) indicates that nominalization involves the changing of a word belonging to a different or particular word class such that the word resulting from the change, functions as a noun. Abu-Bakari outlines two types of nominalization in Dagbani. These are the nominalization of verbs and the nominalization of adjectives. In his discussion, nominalization of other nouns was not mentioned as discussed by some studies in other languages.

Gurundoo (2014, pp.53-55) investigates the morphosyntactic features of the Dagbani verbal phrase. In the study, he indicates that the affixes **-ra**, **-da**, **-na** and **-ta** are verbal affixes which do not have independent semantic content but play rather important functional roles in the language. He further observes that when **-ya** as a particle, is mostly attached to mono syllabic verbs. He adds that some disyllabic and multisyllabic verbs ending in **(hi)** can also be attached with this affix. He notes that **-ra** denotes incompleteness of the action or event when attached to verbs. Also, the study

reveals that when **-da** and **-na** are attached to a verb, they do not take NP or adjunct. They occur in specific phonological environment. This is when a verb ends with a nasal coda. They are in complementary distribution, hence, the choice of one suffix over the other, it largely depended on an individual speaker. Let's consider the examples below;

(17) (a). **bia maa ni ti kani-na ka labi-ra**

baby DEF FUT come-DEI CONJ return

‘When the baby starts coming and going back’.

(b). **A yi nyɛ-la payakpɛma ŋun wum-da**

2SG COND see FOC old lady who listen

‘If you are an old lady listening’.

(c). **Aliru nam-da liyiri nini pɔbibu ni neebu**

Aliru conjure money eye close CONJ open

‘Aliru conjures/ is conjuring money very fast’.

As observed in (17a-17c), any syntactic property that occurs after the particles in examples (17a & b) renders the sentence ungrammatical. This is because they are inherently intransitive and do not take any object. Therefore, the syntactic construction of (17c) is ungrammatical since the word ‘nam-da’ is inherently intransitive and therefore does not take NP or an adjunct.

Furthermore, Gurundoo (2014, p.54) indicates that **-ta** is another verbal suffix and when it is attached to disyllabic verbs with CVCV structure, the verb becomes intransitive and reduces its valency as well. This is illustrated in the example below;

(18)	Binkɔbiga	kam	ɲun	kuli	gari-ta
	Animal	all	who	MOOD	pass-SUFF

‘Any animal that is passing’

As has been illustrated, example (18) has no unit that follows it. This renders it ungrammatical if any syntactic unit follows it.

Although, I share the same view with Gurundoo (2014), however, the current study reveals that these affixes can also function as nominalizers that denote agentive nominals. The study reveals that when these affixes are attached to verbs stems, the nominalized forms/output undergo tonal changes to become nominals. This is discussed in chapter four in detail.

Another work worth reviewing in this current study is Asante (2018, p.16) which discusses some aspects of nominalization in Nkama a less studied and endangered Kwa language of Ghana. Judging from numerous definitions by scholars on the subject, he defines nominalization as “a process that turns a linguistic form/ expression into a noun/ nominal.” Nevertheless, Asante (2018) argued that “the linguistic expression from which the nominal is derived may be a word, a phrase or a clause.” In fact, considering Asante’s definition of nominalization, Dagbani situation fits perfectly well into his categorization because the linguistic expression from which the nominal is derived may be a word or a phrase in Dagbani. However, what has not been established is turning a clause into a nominal. This means that the language may

derive nominals from a word or a phrase. In the study, Asante (2018) comprehensively analyses the processes Nkami language employs to derive noun/nominal from some linguistic expressions including verbs, nouns, phrases or clauses. He examines the types of nominalizations, strategies for forming them as well as some linguistic properties which include morphology, semantics and syntax. Asante (2018) reveals that nouns and verbs can serve as the base concept or the productive strategy of nominalizations in Nkami. He postulates that two types of nominalizations including action and participant nominalizations are evidently exhibited in the language. The study shows that participant nominalization is derived through the means of suffixation only whereas action nominalization is derived through the processes of prefixation, reduplication or compounding. Asante (2018) makes a similar observation in Nkami that, whilst action nominals derived through compounding express only action/ process, those derived through the process of prefixation or reduplication may additionally express situations, states and results.

Unlike Nkami, action nominalization in Dagbani is derived through the processes of affixation by attaching a nominal suffix to the verb root. Also, there is evidence of participant nominalization as a type of nominalization as opines by Payne (1997). The participant nominalization is a morphologically derived strategy through the processes of affixation, reduplication as well as compounding.

According to Payne (1997) cited in Appah (2005, p.1), action is defined as nominalization as the “process by which action nominals are formed from action or non-stative verbs. His study explores the strategies that Akan speakers use as well as the semantic and morpho-syntactic properties to derive the action nominals. He notes that relative to other verbs, the action nominal behaves like a prototypical noun,

occurring in subject and object positions and being the possessed element in a possessive construction. However, relative to the cognate verb, the nominal cannot occur as the subject or object. Therefore, in a post-verbal position, only an adverbial reading is acceptable.

Appah (2005) posits that in Akan, action nominals are derived in two major ways. The first is through a zero operator and the second is through affixation. The examples (19) and (20) describe the means of forming action nominals.

Action nominals through zero operator is the process by which a verb gets used as a noun without a change in its structure. In Akan, the difference between the non-stative verb and the action nominal derived from it is signaled by the tonal pattern of the word (Appah, 2005, p.3).

He examines that Fante, a dialect of Akan, employs the prosodic/phonological strategy in (19), where the derivation of the nominal **nántséw** ‘walking’ (19b) from the verb **nàntséw** ‘walk’ (19a) is based on how the two forms are produced: while the former is produced with a HH tonal pattern, the latter is produced with a LH pattern. For instance, in (19a) the difference between the verb and the nominal is in the tonal pattern. That is, whilst the verb is said on low tone throughout, the nominal is said on high tone throughout. The tonal pattern is that of the surface phonetic forms of the word. When used in discourse, the tonal pattern may change in response to constraints placed on it by neighboring elements. This is shown in the sentences in (19b);

- (19) (a). i. **nàntséw** ‘walk’ (V)
ii. **nántséw** ‘walk(ing)’ (N)

- (b). i. **Kòfí nàntséw ntɛ.ntɛm** (Verb)
 Kofi walks RED.quickly
 ‘Kofi walks very fast.’
- ii. **Nè nántséw yè ntéńtém** (Noun) (Fante)
 3SGPOS walking be fast
 ‘His (manner of) walking is fast’ (Appah, 2003, p. 84)

In the example sentences above, **nantsew** is a verb in (19ai) but a noun in (19aii) though there is no change in the structure of the word. The difference is realized in the tonal pattern of the two words and the fact that the word **nantsew** is the possessed element in the possessive construction in (19bii).

Unlike Fante and Asante Twi as indicated by Appah (2005), Dagbani does not exhibit a similar phenomenon where action nominals are derived through zero operator. What is seen to be case is the fact that there seem to be a tone alternation after a verb stem or root is attached to a suffix nominalizer to derive an action nominal. For example; **bàŋ-dá** (LH) ‘understand/know-progressive’ (V) and **báŋ-dá** (HH) ‘a knowledgeable person’ (N), **vihì-rá** (‘research/search’) (V) and **vihí-rá** (searcher/researcher) (N) are distinguished by tone, this implies that they are words from different lexical categories. Hence, there is no structural change in the words.

Appah (2005, p.4) also explores the second major means of forming action nominals in Akan through affixation. Here, he indicates that ‘‘a nominalizing affix (prefix or suffix or both) is/are attached to some non- stative verb. The prefix can either be a vowel or a homorganic nasal, and it holds true for all the dialects of Akan’’. The suffixes, on the other hand, are dialect-specific. For example, Asante Twi which usually has nominal suffixes has either of the two mid vowels [-e] or [-ɛ]. Fante has only [-w] occurring minimally on a few nominal stems. In (10) are examples of action

nominals derived through affixation and the root from which they are derived. This is followed by the sub-lexical rules and the word structure tree associated with it for action nominalization in (20).

- (20) Akan (Appah 2005, p.4)
- | | | | |
|------|---------------|-----------------|------|
| (a). | dzidzi | e-dzidzi | (Fa) |
| | ‘eat’ | Aff-eat | |
| | | ‘eating’ | |
| (b). | kyerɛw | a-kyerɛw | (Fa) |
| | ‘write’ | Aff-write | |
| | | ‘writing’ | |
| (c). | kekan | a-kenkan | (Fa) |
| | ‘read’ | Aff-read | |
| | | ‘reading’ | |
| (d). | didɪ | a-didɪ-e | (As) |
| | ‘eat’ | Aff-eat-Aff | |
| | | ‘eating’ | |

Like Asante Twi, Dagbani also explores affixation as a means deriving action nominals from non-stative verbs. This is illustrated in the following examples;

- | (21) | VERB | NOMINALIZED FORM |
|------|-------------|------------------|
| (a). | chan | chan-di |
| | ‘walk’ | walk-Aff |
| | | ‘walking’ (N) |
| (b). | di | di-bu |
| | ‘eat’ | eat-Aff |
| | | ‘eating’ (N) |

(c).	do	ɔɔ-bv
	‘weed’	weed-Aff
		‘weeding’

Adomako (2012, pp.49-51) investigated the derivational morphology of the Akan language with particular focus on verbal nominalization through affixation (particularly prefixation). He outlines two ways through which this nominalization process can be realized in Asante-Twi. He opines that the phenomena are direct verb stem/base nominalization and nominalization after reduplication in Asante-Twi. He explains that the main difference between the two nominalization processes is shown to be that while in the former process, the nominal prefixes adjoin the verb stem directly to derive nominals, in the latter process, the same prefixation process also applies but after the reduplication process. He further observes that in the case of the latter process, sometimes the nominal prefix adjoins another prefix; the reduplicative prefix. The examples below by Adomako (2012) illustrate verbal nominalization through direct nominalization by affixation and nominalization after reduplication of verb stem/base in Asante-Twi to demonstrate his point.

(22).	Stem	Gloss	Nominalized	Gloss
(a).	ko	‘fight’	ɔ̀/àkó	‘battle/war’
(b).	hia	‘need/want’	ɔ̀hía	‘poverty’
(c).	tan	‘hate’	ɔ̀tán	‘hatred’
(d).	do	‘love’	ɔ̀dɔ̀	‘love’
(e).	suro	‘fear’	ɔ̀sùrò	‘fear’

In (23) below, Adomako provides more examples of transitive verb stems, however, in deriving this type of nominal, the transitive verb stems select homorganic nasal as the nominal prefix. Below are some examples;

(23). Transitive verb stems with nasal nominal prefixes.

	Stem/base	Nominalized
(a).	pàtá ‘compensate’	mpàtá ‘compensation’
(b).	bòá ‘help’	mmòá ‘help’
(c).	hyirà ‘bless’	nhyirà ‘blessing’

The following verbs do not require direct objects but only the subject. The only thing that their nominal vowel prefixes have in common is the feature value [-High].

(24). Intransitive verb stems with vowel nominal prefixes.

	Stem/base	Gloss	Nominalized	Reduplicated	Gloss
(a).	sá	‘dance’	àsá	*a.sa-sa	‘dancing’
(b).	nyìní	‘grow’	ènyìní	*e.nyini-nyini	‘growth’
(c).	mùná	‘frown’	èmùná	*e.muna-muna	‘a frown’

Adomako (2012) indicates it is not only the regular verb stems which can be nominalized in Akan. There are irregular verbs in Akan as well which are nominalized in the same way as their regular counterparts. The following data in (25) are some examples of such verbs and how they are nominalized. They are irregular in the sense that unlike the regular verb stems, they require both the nominal prefixes and suffixes for their meanings to be complete. These verb stems are not very productive in Akan.

(25). Irregular verb stems with nominal prefix and suffix

	Root/Base	Gloss	Derived-form	Gloss
(a).	bó /bóró	‘beat’	ébòró	‘beating’
(b).	bó / bóró	‘get drunk’	ebòró	‘drunkenness’
(c).	sòró	‘to be naughty’	èsoró	‘naughtiness’

Even though the focus of this study is on nominal prefixation, Adomako also discussed nominal suffixation for a more complete view of nominalization in Akan.

Consider the following examples:

(26). Low vowel raises to high front vowel

	Stem/base	Reduplicated form
(a).	da? 'sleep'	di.da?
(b).	ka? 'bite'	ki.ka?
(c).	da? 'coop'	si.a?
(d).	kan 'read'	kiŋ.kan
(e).	tam 'lift'	tiŋ.tam
(f).	bam 'embrace'	biŋ.bam
(g).	pam 'sew'	piŋ.pam

The data below exemplify instances of raising to the high back vowel in the reduplicant in both simple CV and CVN syllable shapes.

(27). Mid-back vowel raises to high back vowel

	Stem/base	Reduplicated form
(a).	sa? 'mend'	su.sa?
(b).	da? 'weed'	du.da?
(c).	pan 'close'	puŋ.paŋ
(d).	do 'love'	dudu

The work of Adomako (2012) is very relevant to the current study in that both studies examine nominalization processes. Whilst Adomako (2012) study looks at a verbal nominalization, the current research deals in all aspects of nominalization including verbal nominalization. Unlike Asante-Twi, where affixation (prefixation) and reduplication as morphological processes uses to derive the nominal in different strategies, Dagbani employs suffixation, compounding and reduplication in deriving nominals.

Asamoah (2014) conducted a toponomastic study of some Asante-Twi habitation names from a morphosyntactic perspective. The study considered the morphological and syntactic structure of about one hundred and sixty (160) Asante-Twi habitation names. In the study, some habitation names were collected from both primary and secondary sources. The researcher adopted the primary and secondary as data sources by employing semi-structured interview to ascertain the complete structure of the names since some names have either been wrongly written or might have undergone some phonological processes. Again, a purposive sampling technique was employed in the selection of the sample size. The researcher also used inductive and creative synthesis approach to categorize and code the habitation names under the right morphological and syntactic divisions. The typology of Asante-Twi habitation names was also examined under two broad areas which are morphological analysis and syntactic analysis. Through the morphological analysis some Asante-Twi habitations the study showed evidence of single stems, compounds, affixation and reduplication as morphological processes Asante exhibits. Even though Asamoah (2014) investigated Asante-Twi habitation names, this study examined nominalization in Dagbani. This study will help ascertain the morphological and syntactic aspects of nominalization in Dagbani.

According to Anyanwu and Omega (2015), nominalization is the process of deriving a noun from some other word classes. The paper focuses on some aspects of deverbal nominalization in Tee spoken in Nigeria. In relation to lexical nominalization, they describe as a process that derives a noun from some other lexical category, typically a verb or adjective, by modifying the root. This can be via a morphological process as in English (e.g., legal, legalize and legalization). The study focuses mainly on lexical nominalization and it aims at providing a preliminary descriptive account of an aspect

of lexical nominalization in Tee; the deverbal lexical nominalizations. Based on the data presented, the study demonstrates that morpho-phonological processes are involved in the derivation of Tee deverbal agentive, infinitives, gerundives, action nouns and qualificative nominals. They explain that generally, the deverbal nominalizations are primarily achieved by a morphological process of prefixation which carries either the mid tone or low tone which also triggers tonal changes in the verb root of the derived nominals.

In discussing deverbal nominalization in Tee, Anyanwu and Omega (2015, p.6) observe that deverbal nominalization is achieved by some morpho-phonological strategies and derived deverbal nominals can be sub-classified into participant nominalization and action/state nominalization. According to them, derived agentive nominals are examples of participant nominalization while the gerundive, infinitive, derived action nouns and derived qualificative nouns are examples of action/state nominalizations.

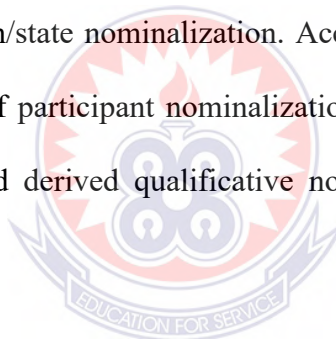

The study relates to the current study because both look at nominalization within the context of lexical nominalization. The types and strategies involved in deriving the verbal nominal are discussed in both studies. However, previous study by Anyanwu and Omega (2015) focuses only on deverbal nominalization while the current study discusses other aspects of derived nominals including deverbal nominalization.

In considering Comrie and Thompson (1985) and Matthews (200, p.244) definition of nominalization, Ofori (2013) sees nominalization as the process which involves the formation of a noun from some other word classes. He also sees nominalization as "... any process by which either a noun or a syntactic unit functioning as a noun is derived from any other kind of unit". In his study of Anum grammar, (Ofori, 2013)

discusses the use of nominalized verbs as noun phrase heads and agentive nominalization in Anum. He indicates that action nominalization in Anum involves tonal changes on the tonal pattern of the verb root which serves as the imperative and the uninflected form of the verb.

The following examples in (28) below show his observation:

28.	Verb	Nominalized form
(a).	màsí ‘laugh’	mási ‘laughter’
(b).	fòkyí ‘sweep’	ǎfókyì ‘sweeping’
(c).	bílí ‘speak’	mbíli ‘speaking’

It could be seen from the examples above that whereas the imperative forms take a low-high tone pattern, the nominals take a high-low tone pattern. It should also be noted that some of the verbal nominals take some of the noun prefixes like **ǎ-/o** (example 28b) and some take the homorganic nasal as in example (28c) above.

Unlike Anum, action nominalization in Dagbani is morphological. The action nominalization involves a verb stem attaching to a derivational suffix (nominalizer) to form the action nominal.

In discussing agentive nominalization, Ofori (2013) mentions that available data show that agentive nominalization are very productive in Anum. The agentive nominalization process in Anum involves the addition of the suffix ‘**hɔ**’ to a nominalized action verb. The suffix ‘**-hɔ**’ is invariant, in that it occurs for both singular and plural derived nominals; it does not distinguish between male and female referents and it does not conform to vowel harmony rules. These nominals also take noun prefixes. Like Anum, agentive nominalization process is very productive in Dagbani. It involves the affixation of the suffixes ‘**-ra**’, ‘**-da**’, **-na** or ‘**-li**’ to verb

stems or bases to derive agentive nominal. He outlines the following examples in (29a-f) below:

(29). **Agentive Nominals derived from verb stems in Anum**

	Stem	Singular	Plural
(a).	fi ‘to sell’	àfi: hō ‘seller’	èfi: hō ‘sellers’
(b).	gyi ‘to eat’	ægyi: hō ‘glutton’	égyihō ‘gluttons’
(c).	bili ‘to speak’	æbilihō ‘speaker’	æbilihōéni ‘speakers’
(d).	nùú ‘to drink’	àtènúúhō ‘drunkard’	ètènúúhō ‘drunkards’
(e).	bà ‘to sew’	àbááhō ‘tailor’	èbááhō ‘tailors’
(f).	kè édé ‘to teach’	èdèkééhō ‘teacher’	èdèkééhō éni ‘teachers’

In the examples (29a-c) above, in Anum it can be realized that a prefix **a/æ** is affixed to the verb stem and the agentive suffix **-hō** is added to derive the nominalized form. However, in example (29f) in which the verb **kè** takes an obligatory complement, there is a complement verb inversion in the formation of the nominalized form before it is prefixed with /**è**/ and suffixed with **-hō**.

The examples below outline the formation of agentive nominals with different nominalized suffixes in Dagbani.

(30)	Verb Stem	Singular	Plural
(a).	wum ‘listen/hear’	wum-da ‘listener’	wumdiba
(b).	da ‘buy’	da-ra ‘buyer’	dariba
(c).	baŋ ‘to learn’	baŋda ‘a knowledgeable person’	baŋdiba

The examples above illustrate different agentive nominalizers in deriving agentive nominals in Dagbani through affixation. It is important to note that these nominal

suffixes are invariant, that is to say that they occur for both singular and plural derived nominals; it do not distinguish between male and female referents and they do not conform to vowel harmony rules either.

Furthermore, Akrofi-Ansah (2012, p.7) describes how action nominalization operates in Lete, a south Guan and generally a Kwa branch of language of Ghana. Akrofi-Ansah (2012, p.9) explores morphosyntactic properties that the action noun shares with a prototypical Lete noun phrase. Her study opines that Lete uses two strategies in deriving action nominals from action verbs. One mechanism involves a tonal change (prosody in the literature) whilst the second strategy is syntactical (object-verb reversal order). She adds that the derived noun possesses some morphosyntactic properties just as the prototypical noun phrase.

Both studies explore how action nouns are derived from action verb however, unlike Lete, action nominals are derived through tonal change and syntactic strategies, whilst Dagbani employs morphological and syntactic (word order reversal of a verb phrase) strategies in deriving action nominals from action verbs. The present study also examines other aspects of nominalization such as agentive, patient, locative types of nominalization among others.

Again, another related work worth mention is Bisilki (2019). Bisilki (2019, p.13) discussed nominal derivation which focused on posture verbs in Likpakpaln (Konkomba). It uses a corpus data drawn from both natural discourse and elicitations without any theoretical inspirations by examining how posture verbs are nominalized. The study observes that a morphological strategy is adopted in posture verb nominalization. Likpakpaln employs prefixation and reduplication processes to derive nouns from posture verbs. Furthermore, it revealed that nouns derived from posture

verbs can be used figuratively to have different semantic features (meaning) from the denotative meaning of posture verbs in Likpakpaln (Konkomba). Bisilki observes that the nominal adopts a concatenated process of prefixation and reduplication from Likpakpaln posture verbs. From his analysis, it shows that few posture verbs are found to be nominalized through prefixation, the rest of the posture verbs from the data identified, required the simultaneous process of prefixation and reduplication of the verb base.

Bisilki (2019) focused only on how Likpakpaln posture verbs can be nominalized whilst the present study captures other aspects of nominalization where posture verbs are subsumed in the study.

Adeniyi (2010) examined tone and nominalization interaction in Edo, a minority language spoken in Nigeria. According to him nominalization is a process of deriving nominals from a combination of other lexical categories or phrasal entities. In Edo, a noun is formed from a combination of a prefix and a verb phrase or from the combination of a prefix and other lexical categories. He opines that nominalization in Edo is characterized by complex morphotonemic alternation where these tonal reflexes are syntax driven. The tonal patterns noticeable in the nominalization in the language are triploid/threefold. The first involves the creation of an all-low tone pattern from diverse input; the second involves tone polarization also from diverse inputs; in the third case, there are no tonal changes after collocation. Syntactic reasons account for these diverse outputs. First, the prefixal nominalization that causes an all-low tone involves non-gerundive nominals, while those that create polarization produce gerundive nominals. It must, however, be noted that both polarization and the creation of an all-low tone pattern take place with nominalization after vowel elision.

After collocation, what we have is either an all-low tone pattern or an LHL (H) tonal pattern. The structure of Edo nominalization in his work can be represented as:

	Noun prefix + vb + (vb) + Nn + Nn			Nominalization
(31). (i)	o #	dolo #	èvbo	odolèvbò
	Nom.prefix	‘to reconcile’	‘people/kind’	‘social conformist’
(ii)	í #	ghe #	egbe	íghegbe
	Nom.prefix	‘to support’	‘body’	‘self-support; security’
(iii)	o #	so #	araba	osoaraba
	Nom.prefix	‘to tap’	‘rubber’	‘rubber tapper’
(32). (i)	o #	le #	íze	o lize
	‘Nom. prefix’	‘cook’	‘rice’	‘boiling rice’
(ii).	ò #	to #	oxa	o toxa
	Nom. prefix	‘tell’	‘story’	‘a story teller’
(iii).	Ò #	kpa #	ekpetí	okpaekpetì
	Nom. prefix	‘make’	‘box’	‘maker of boxes’

It is observed from the examples tone plays very role in nominalization in Edo. The demarcation of different types of nominalization in Edo was based clearly on the different tones they bear. Like Edo, Dagbani nominalization is morphological; however, Dagbani employs nominalizing suffixes while Edo displays different prefixes in deriving nominals. The study employs Auto-segmental theory in its data analysis while the current study adopts the basic linguistics theory (BLT) by Dixon (2009, 2010 & 2012) in its data analysis.

Yukari (2016) accounts for nominalization in Alutor, a language of the Chukchi-Kamchatkan family. The study looks at verbal nominalization through morphological processes. He outlined four types of nominalization such as action/ state, instrumental nominalizations, locative and agentive/objective nominalizations. According to Yukari (2016) in deriving action nominal, a suffix ‘-yərŋ’ is attached to a verbal stem. He adds that nouns derived by this suffix often indicate abstract concepts. He also observes that the underlying verbal stems may be intransitive or transitive as in (33a-33c).

(33).	Verbal stem	Suffix -yərŋ
(a).	junat-ə-k live-E-INF ‘to live’	junat-yərŋ-ə-n live-NMLZ-E-ABS.SG ‘life’
(b).	tek-ə-k make-E-INF ‘to make’	tek-ə-yərŋ-u make-E-NMLZ-ABS.PL ‘products’ (lit. ‘Things that were made’)
(c).	waŋi-sit-ə-k sew-intensively-E-INF ‘to compete on sewing’	waŋi-sit-yərŋ-ə-n sew-intensively-NMLZ-E-ABS.SG ‘sewing competition’

It is also observed that action nouns cannot have core arguments; instead, as in (33), the subject of the nominalized verb stands in the possessive form. In deriving instrumental nominalization, nouns indicating instrument are derived from verbal stems by the suffix -inaŋ as in (34a). The initial vowel /i/ is dropped when the verbal stem ends in a vowel (34b).

(34)	Verbal stem	+	Suffix -(i)naŋ
(a).	ujisvat-ə-k play-E-INF ‘to play’		ujisv-inəŋ play-NMLZ ‘toy’

(b).	kaɲu-k	kaɲu-naɲ
	gaff-INF	gaff-NMLZ
	‘to gaff’	‘gaff, hook’

Both studies look at nominalization and types and exhibit morphological process as a productive nominalization strategy. Unlike Alutor, Dagbani employs different verbal nominalizers in nominal derivation.

Henry and Amy (2002, p.255) explore the morphological, syntactic and semantics of nominalization in Kavalan. Drawing insights from different definitions of nominalization from many linguists, they define nominalization as a grammatical process by which a verb, a verb phrase, a sentence or a portion of a sentence including the verb can function as a noun phrase. The study shows that nominalization and headless relativization in Kavalan which are both subsumed under the realm of nominalization in the literature, are morphologically, syntactically and semantically distinct. They posit that while the former is marked by nominalizing suffix **-an**, the latter is by the complementizer clitic = **ay**. In discussing action and state nominalization, Henry and Amy (2002, p.356) posits that action nominal and state nominal in Kavalan take different morphological markings when they undergo nominalization such that whilst the former is marked with the suffix **-an**, the latter is marked with the prefix **qna-**. The following examples outline action and state nominalizations distinction in Kavalan;

(35)	(a).	nengi sanu-an	na	sunis a	yau
		good	educate-Nmz	GEN	child Lig that
		‘That child’s education is good.’			

- (b). **qa-sianem = iku tu kerawkaway-an-ku**
 think = 1S.NOM ACC work-NMZ-1S.GEN
 ‘I am thinking/worrying about my work.’
- (36) (a). **m-rizaq = iku qena-lilumen-na**
 AV-like = 1S. NOM NMZ-honest-3S.GEN
 ‘I like his honesty’.
- (b). **maytis tu qena-subunga-na**
 fear ACC NMZ-lonely-3S.GEN
 ‘He fears loneliness.’

The action nouns **sanuan** ‘education’ and **kerawkawayan** ‘work’ are suffixed with **-an**, as shown in (37), while the state nouns **qenarilumen** ‘honesty’ and **qenasubunga** ‘loneliness’ are prefixed with **qena-**. Furthermore, some state nouns may take suffixed **-an**. Consider the examples below:

- (37) (a). **mai utani qena-sianem-an-na**
 NEG much NMZ-learn-NMZ-3S.GEN
 ‘His knowledge is not much.’
- (b). **mai tu qena-siqal-an razat a yau**
 NEG ACC NMZ-polite-NMZ person LIG that
 ‘That person has no politeness/shame.’

The study also discusses agentive nominalization in Kavalan where an agentive noun is formed by attaching the affixer complex **pa-...-an** to a source verb:

- (38) (a). **babaran na pa-Ribaut-an sunis a yau**
 hit GEN NMZ-to fish-NMZ child LIG that
 ‘The child was hit by the fisher.’
- (b). **mazmum pa-taqsi-an-ku**
 many NMZ-study-NMZ-1S.GEN

‘My students are many (in number).’

- (c). **nengi pa-zazas-an na lamu**
 good NMZ-lead-NMZ GEN village

‘The village leader is good.’

- (d). **tmingaR = iku tu pa- kerawkaway-an**
 hire = 1S.NOM ACC NMZ- work-NMZ

‘I hire a worker.’

In (38a), the meaning ‘fisherman’ is grammatically represented as paRibautan, where the source verb Ribaut means ‘to fish’ and the affixer complex **pa-...-an** turns the source verb into an agentive noun. The affixal complex **pa-...-an** is similar in function to the English agentive suffixes **-er** or **-or**.

Unlike Kavalan, Dagbani attaches a simple affix usually a suffix ‘**-na**’, ‘**-ra**’, ‘**-ta**’ to a source verb stem. Agentive noun is also formed by processes of conjoining a verb and a noun plus a suffix nominalizer.

- (39) (a). **Zuŋɔ shinkaafa da-ra bi kana daa**
 today rice buy-NMZ NEG come market

‘Today the rice buyer did not come to the market’.

- (b). **Adam nyɛ-la wawara ni achiika**
 Adam be-COP dance-NMZ CONJ true

‘Adam is really a good dancer’

In the above illustrations, the agentive noun is realized through suffixation as in (39a) and compounding plus suffixation as shown in (39b). Like Kavalan, Dagbani exhibits morphological process by deriving action nominals from action verbs.

Galucio (2011, p.3) studied Mekens nominalization, a language which belongs to the Tupari branch of the Tupi family spoken in the north-western part of Brazil. Her study investigated the morpho syntactic and semantic properties of the distinct forms of

deverbal nominalization in Mekens. Gulicio (2011) explains that lexical nominalization is expressed in Mekens by means of two morphemes. She describes these morphemes as circumstantial nominalizer **-ap** and participial nominalizer **-pit**. Galucio adds that both morphemes derive nominal forms from transitive and intransitive verbs.

In relation to the circumstantial nominalizer **-ap**, Galucio (2011) posits that the morpheme is most productive in nominalization in Mekens, which refers to instrumental and locative nouns. She claims that both transitive and intransitive verbs may be nominalized through this morpheme, but according to her, the resulting nominalization shows distinct semantic and lexical properties based on the category of the base. She further observes that, generally, the circumstantial nominalizer suffix derives instrumental nouns from transitive verbs while the place nouns from intransitive verbs. The example below illustrates her discussion.

- | | | |
|-------|-------------------------|--|
| (40). | Otat poka | otat poka -ap |
| | Fire burn/light | fire burn/light-NMLZ |
| | ‘light the fire’ | ‘match or lighter’ (lit. tool (for) lighting fire) |
| (41). | Kwe mi -a | mi-ap |
| | Animal shoot/kill- TH.V | shoot/kill -NMLZ |
| | ‘shoot/kill an animal’ | ‘weapon’ |
| (42). | Se-ekwe-a-t | iki ekwe-ap |
| | 3c-run-TH-V-PST | water run-NMLZ |
| | ‘he ran’ | ‘rapids’ |
| | | (lit. part of a river where the current is swift)’ |

(43).	Otoa kot ot	o- to- ap
	1S- lie- FUT. I	1S lie –NMLZ
	‘I will lie down’	‘my hammock or my bed’
		(lit. place where I lie down to sleep)

From the examples above, it can be seen that the deverbal nouns formed by attaching the morpheme **-ap** to the verb stem to indicate/show instrument nouns derive from the transitive verbs **-poka** ‘to burn’ and **mi** ‘to kill’ in (40-41) while examples (42-43) show place nouns derive from the intransitive verbs **ekwe** ‘to run’ and **to** ‘to lie down’.

Unlike Mekens, Dagbani may employ the same or different derivational suffixes as a strategy to derive both instrument and locative nominalizations. Morphologically, suffixes such as **-gu**, and **-a** are instrument nominalizers. The locative nominalization is formed from attaching suffixes such as **-shee**, **-a** and **-ni** to verb stems or roots as exemplified below;

(44).	Verb root	Nominalizer	Nominalized form
(a).	ga ‘dig’	-a	gaa ‘type of a hoe’ (INSTR)
(b).	da ‘buy’	-a	daa ‘market’ (LOC)
(c).	doo ‘lying’	-shee	dooshee ‘place to lie’ (LOC)

It can be observed from the above examples that same nominalizer is been used to derive both instrument and locative nominals as shown in (44a & 44b) depending on the choice of the verb.

The very first research works on the linguistic study in Dagbani include Wilson and Bender-Samuel (1965), Wilson (1972), Olawsky (1999). In those works, phonemes of Dagbani, morphophonemic patterns of nominals and some phonological issues were

discussed. They argue that some nominals of Dagbani have no suffix in the singular and therefore form their plurals by attaching the suffix **-nima** to the nominals. For instance, nominals like **ba** ‘father’, **ma** ‘mother’, **karante** ‘cutlass’, **zo** ‘friend’ and **cheche** bicycle do not exhibit singular suffixes but their plural forms are indexed by the element **-nima**. However, there are some nouns in Dagbani which have suffixes indexing singularity and derive their plurals by attaching the suffix to the roots/stems of the nouns. For example, nouns like **na-a** ‘a chief’ and **son-ya** ‘a witch’ form their plurals by replacing **-a** and **-ya** with **-nima**.

Wilson (1972) looks at the various aspects of grammar with special emphasis on tone and nominal inflection in the language. Dagbani is a tonal language and pitch is phonemic. This assertion suggests that in the language tone brings about change in meaning among word forms of the same morphological structure. For instance, words in Dagbani like **báá** (HH) ‘dog’ and **bàá** (LH) ‘marshy ground’ have the same morphological structure but semantically, they are distinguished by tone.

Another research work on the language by a non-native is Olawsky (1999). Olawsky dealt with the grammar of Dagbani with special emphasis on phonology and morphology. He also observed that in contrast to simplex nouns, derived nouns do not have a number suffix. To him, most derivative affixes transform a noun, a verb or a word of another category into a word that exhibit a more abstract and non-countable character, usually a noun. He adds that in simple derivations, the base of a word is conjoined with a suffix. Here, the derived word may denote a different meaning than the original word and may belong to a different grammatical category than the underived word. For example, the words **ku** ‘kill (V)’, **bahi** (V) ‘finish’ and **kasi**

(Adj) ‘holy’ are transformed into nouns by the suffixation of [-m], [-gu] and [-tali] respectively, as (45) illustrates

- (45) (a). **ku** ‘kill (V)’ **ku-m** ‘dead/death’
 (b). **bahi** ‘finish (V)’ **bahi-gu** ‘end’
 (c). **kasi** ‘holy (Adj)’ **kasi-tali** ‘holiness’

It is therefore, not always straightforward to determine the category of the original root and exact meaning of and perhaps function of the derivative suffix. Olaswky (1999) in effect, also looked at some derivative suffixes productive in forming nouns in the language. These include, the **-bu**, **-gu**, **-m**, **-lim**, **-sim** among others.

Another useful work on Gur language is Bodomo (1997). He looks at the structure of Dagaare where he outlines some number of derivational processes in Dagaare which is worth discussing in this current study. According Bodomo (1997), nominalization involves the formation of nouns from verbs and adjectives. In Dagaare, nominalization involves the nominalization of verbs, adjectives and nouns. He observes that in Dagaare, the process involves vowel lengthening or diphthongization in short vowels. To nominalize verbs, it involves affixation process, normally addition of suffixes such as **/-rɛ/**, **/-bu/** **/-bu/**, **/-mo/** **/-bu/** to the verbs. To nominalize adjectives, the process involves attaching suffixes to adjectives to derive nouns in Dagaare. It has been established that Dagaare has only three suffixes. These are **-loŋ**, **luŋ**, & **-ruŋ**. The examples below illustrate nominalization of verbs and adjectives in Dagaare to demonstrate his point.

- | (46) | Verb | Nominalized item |
|------|----------------------|---|
| | (a). zo ‘run’ | zoou/ zoobu ‘the act of running’ |

(b).	tɔ ‘touch’	tɔɔo/toɔbo ‘the act of touching’
(c).	gaa ‘go’	gaaɔ/gaabo ‘going/ departure’
(47)	Adjective	Nominalized item
(a).	sɔɔglaa ‘black’	sɔɔɔlɔŋ ‘blackness’
(b).	paalaa ‘new’	paalɔŋ ‘newness’
(c).	baalaa ‘soft’	baalɔŋ ‘softness’
(d).	faa ‘bad’	faalɔŋ ‘bad deed, evil’

Fatawu (2018) carried out a morphosyntactic study regarding personal names with emphasis on proverbial names in Mampruli, a Gur language of Ghana using the frameworks of lexical morphology by Katamba (1993) and the lexical functional grammar by Bresnan (1974) and Falk (2001). The study relied on semi-structured interview, conversations and recordings to elicit data from thirty (30) native speakers of Mampruli to represent the entire Mamprugu kingdom. The sample was purposefully selected to meet the demands of the study. The study revealed that are the common morphological processes that are involved in the formation of personal proverbial names in Mampruli are compounding and affixation. Available data in the study also indicated evidence of Elision and assimilation as major phonological processes in the formation of these names. The study also revealed that different compound names in Mampruli belong to the same grammatical category (nouns). This study will help in the analysis of the morphological, syntactical and phonological processes that take place in turning grammatical categories into nouns in Dagbani.

Abdul-Rahman (2013) investigates Elision in Dagbani. The study seeks to share light on elision as a prominent syllable structure process in compound word formation in Dagbani. His data were analyzed data under the framework of Autosegmental phonology. He argues that, noun-noun compounds, noun-adjective compounds and a few verb-verb compounds cause elision in Dagbani.

He observed also that elision occurs in plural formation in Dagbani. He contended that, the environment in which elision occurs is always at word boundaries and that the elision in Dagbani is a leftward one. The following vowels [a, o, u], the nasals [m, ŋ] and syllables as segments that are mostly affected by the elision process in Dagbani were identified in his study.

I therefore indicate that elision occurs when words are compounded or a suffix is attached to either verbs or nouns to derive a nominal in Dagbani. As observed in this study, the process of deriving nominals through compounding and affixation, may trigger elision through some compound types such as; noun-noun, noun-adjective, verb-verb or noun-verb. The elision in Dagbani is a leftward one and it occurs at word boundaries as Abdul-Rahman (2013) argues is the case of Dagbani.

2.5 Morphological processes of nominalization identified in Dagbani

Morphology is subfield of linguistics that is concerned with analysis of the structures of words. It is viewed as how words are formed in languages. Languages have different ways of forming or adding new words into the language. Some languages can have the same process of forming words. Morphology thus, refers to that branch of language studies which deals with what morphemes are and how those morphemes operate in the structure of a word (Thakur, 2010). Nida (1949, p.1; Caesar, 2013, p.29) defines morphology as “the study of morphemes and their arrangement in

forming words.” Morphology is also simply defined as the study of word structure (Katamba, 1993).

Considering the definitions discussed, the focus is largely on the analysis of words and their structures. Morphological analysis is seen as an attempt made to capture the structure of languages at the word level or concerned with the ‘forms of words’ (Matthews, 2000). Morphological processes are ways in which bound and free morphemes are put together to create new forms. A morphological pattern is a set of associations and operations that build the various forms of a lexeme possibly by inflection, compounding, borrowing compounding, reduplication, back formation, clipping, stem modification and suppletion among others (Anindo, 2016). A lot of morphological processes take place in the formation of personal proverbial names in Mampruli, nominalizations in Nkami and Anum, verbal derivations in Akan (C.f. Appah, 2003, 2005; Adomako, 2012; Ofori, 2013; Fatawu, 2017 & Asante, 2016, 2018).

In this chapter, I reviewed several nominalization strategies used in Dagbani. These processes or strategies are done through various procedures which are affixation, compounding, and reduplication. In the formation of nouns from grammatical categories in most languages, there is much evidence that there are a lot of morphological processes that take place. Hence, the most common morphological processes that are involved in the transformation of some grammatical categories either verbs or other nouns in Dagbani include affixation, compounding and reduplication. These processes are all productive as far as nominalization in Dagbani is concerned. Each of these processes is discussed in the following subsections.

2.5.1 Affixation

Another interesting and productive morphological process that takes place in nominalization in Dagbani is affixation. This is a morphological process where words are derived by the addition of affixes. It is the morphological process in which an affix is attached to a root or a base (Kibet, 2016). Leiber (1980) also states that “affixes are considered as lexical entries that are combined with lexemes in a combinational fashion as lexical entries. Sometimes, it is the combination of a root and another root which has attached itself to an affix”. Affixation involves the addition of suffixes, prefixes, circumfixes and infixes in some languages. In the words of Fatawu (2018) “affixation involves the addition of suffixes, prefixes, circumfixes and infixes in some languages.” Similarly, Agbedor (2010) also shares the same view that adding affixes to the base or root to generate a different word form or new word is affixation. That is to say that it is the morphological processes that contribute greatly to how new words in many languages are created. The above definitions of affixation apply to Dagbani.

Affixation in Dagbani mainly consists of suffixation, it is a very productive nominalization pattern that creates instrumental, stative, action, agentive, location and manner, nominalizations to name but a few. Consider the following illustrations in (48);

(48)	Verb Infinitive	Nominalization Base +Suffix	Nominalized verbs Nouns
(a).	paŋ ‘borrow’	paŋ-bu	paŋbu ‘borrowing’
(b).	di ‘eat’	di-bu	dibu ‘eating’
(c).	chaŋ ‘walk’	chan-di	chandi ‘walking’
(d).	la ‘laugh’	la-ri	lari ‘laughter’

The examples above show the affixation process that Dagbani employs in turning or transforming nouns from verbs. In deriving the nominal morphologically, the language uses various derivation suffixes. These affixes (suffixes) are attached to stems or roots of grammatical categories to derive nouns.

2.5.2 Compounding

Compounding can be characterized as a combination of different roots or words to create a new word. The meaning of the newly formed item may not necessarily reflect the meaning of its single components. When two or more words are joined to make a longer word, the process is known as compound-formation. A compound word can be noun, a pronoun, an adjective, verb among others. He adds that the only word class in English which can never occur in the form of a compound word is the article (Thakur, 2010, pp.61-62). A compound word also contains at least two bases that are both words, or at any rate, root morphemes Katamba and Stonham (2006, pp.55-56). In my view it involves the combination of lexical categories like nouns, verbs and adjectives. For instance, when ‘boy’ and ‘friend’ are conjoined, the new word ‘boyfriend’ is formed.

It is a part of nominalization process that Dagbani employs in its derivational processes that involves various word pairings that generally result in opaque meanings. (Olawsky (1999), Abu-Bakari (1988), Abdul-Rahaman (2013) and Abukari (2018). In the following examples, I discuss some identifiable types of compounds in Dagbani. It is observed that Dagbani mostly exhibits a form of compound in which words are combined together. There are compounds that are created by combining two nouns as shown in the following examples.

(49). **Process of deriving nouns through compounding**

	A	B	C(A+B)	Ill-formed
(a).	kariŋ ‘studies’	ba ‘father’	karimba ‘teacher’	*kariŋba
(b).	kariŋ ‘studies’	bia ‘child’	karimbia ‘student’	*kariŋbia
(c).	kariŋ ‘studies’	zɔŋ ‘local hall’	karinzɔŋ ‘classroom’	*kariŋzɔŋ

In the above data which is $[N+N]$ compounding, suggests that among the columns labelled **A**, **B** and **C(A+B)**, elision takes place in **C(A+B)**. It is important to note that in process of compounding of words, assimilation process is triggered. The nasal coda in (49a-c) in the first word assimilates to the place of articulation of the adjacent consonant. The preceding consonant which a velar nasal assimilates to the place of articulation of the following segment which is a bilabial. This phenomenon is termed nasal place assimilation. The examples of compounds provided above show evidence of a head rule in Dagbani. Dagbani compounds seem to follow a “Left Hand Head Rule” (Abdul-Rahaman, 2013). Per the data in (49), failing to delete the final segment (velar nasal) in the first noun will yield a wrong phonotactics construction based on the semantic feature of the noun when compounded.

2.5.3 Reduplication

In reduplication, a new word is formed by doubling an entire free morpheme (total reduplication) or part of it (partial reduplication). Dagbani has five different kinds of reduplication, one type that is discussed in this study is the one that involves the formation of action nouns. This type of reduplication is termed as pseudo-reduplication. This is because the category and the meaning of the base is unclear in most cases, thus, it is difficult to identify a free morpheme as the base. Reduplication

in Dagbani can be simple or complex Issah (2011), Abu- Bakari (1980), Adam (2007) and Olawsky (1999). This type of reduplication focuses on nominal reduplication. Simple reduplication refers to reduplications where the total word is repeated without anything else being added to the word.

2.6 Some Phonological Processes in Dagbani which are Relevant to this Study

Phonological processes are the life blood of phonology. According to Schane (1973, p.43), “phonological processes refer to some changes that occur when segments are juxtaposed.” Following (Kuubezelle, 2003), “phonological processes refer to the changes that take place in sounds when segments are juxtaposed.” In view of this, a part of the work discusses the phonological processes that are specific to Dagbani. In this study, I will be discussing vigorously such phonological processes (phenomena). These processes are assimilatory processes and syllable structure processes in Dagbani.

2.6.1 Assimilatory Processes

Schane (1973, p.49) states that in “assimilatory processes a segment takes on features from a neighboring segment.” Katamba (1989) also observed that, assimilation is the modification of a sound in order to make it more similar to some other sound in its neighborhood, with the aim of making a smoother, more effortless, more economical transition from one sound to another. In the light of this, there is an influence of one sound segment on the articulation of another such that the two sounds become more alike or identical (Crystal, 1997, p.30). Assimilation is a widespread phenomenon in the languages of the world. Segments that undergo change may either be partially or completely assimilated. The assimilatory process may also relate to the direction of the influence or the contiguity of the segments involved. In terms of direction, the

process may be regression (anticipatory) or progression (perseverative), which is a preceding segment may cause another to change its qualities or a segment that comes after another may condition the change. In relation to contiguity, the segments involved are either directly in contact or they may influence each other from a distance across intervening segments (Lass, 1984, p.171).

2.6.1.1 Homorganic Nasal Assimilation (H.N.A)

Generally, when a nasal consonant precedes an obstruent sound in Dagbani, the two consonants become homorganic: they agree in articulation (Lass, 1984, p.48). Homorganic nasal assimilation is the assimilation process whereby a nasal consonant inherits the place of articulation of a plosive (Durand, 1990, p.100). When homorganic nasal assimilation (H.N.A) occurs the final consonant segments in the first syllable assimilate the nature of the next consonants so that they make for ease and economy in the process of communication. In Dagbani, homorganic nasal assimilation process operates during word formation processes. Perhaps, the most important point at which homorganic nasal assimilation (H.N.A) is very pervasive in the language is when two morphemes or roots are put together to create a new word. As the word final nasal is placed next to initial consonants in an adjoining word, it usually assimilates the place of articulation of the following consonant. Consider the following examples (50).

(50). H.N.A in compound words

	NOUN	NOUN	NOMINALIZED FORM
(a).	kariŋ ‘studies’	ba ‘father’	karimba ‘teacher’
(b).	kambɔŋ ‘barn’	bila ‘small’	kambɔmbila ‘a small barn’
(c).	kariŋ ‘studies’	bia ‘child’	karimbia ‘student’

- (d). **gungɔŋ** ‘a barrel’ **biɛyɔ** ‘bad’ **gungɔmbiɛyɔ** ‘a dirty barrel’

As seen in the above data, in the first example, **karimba** ‘teacher’ for instance, homorganic nasal assimilation is observed at the second syllable, a velar nasal becomes bilabial nasal, thus conforms to the voiced bilabial articulation of /b/. In the second example too, the velar nasal becomes a bilabial nasal /m/ because of the influence of the following segment /b/ which is bilabial.

In possessive constructions in Dagbani, as observed in the examples below; the possessive pronoun /n/ “my” becomes the bilabial nasal /m/ in most natural occurring speech. This nasal is also the first-person pronominal form and, in all instances, it assimilates the place of articulation of the initial consonant of the following noun (in the case of possessives) or verb (in the case of the pronoun). The examples (51) and (52) illustrate this phenomenon.

(51) **HNA in possessive constructions**

- | | | | | |
|------|------------|---------------|----------|------------------|
| (a). | n | bɔyɔ | m | bɔyɔ |
| | 1SG | arm | | ‘my arm’ |
| (b). | n | furila | ŋ | furila |
| | 1SG | lamp | | ‘my lamp’ |
| (c). | n | gayili | ŋ | gayili |
| | 1SG | can | | ‘my can’ |

(52) **HNA in 1st person pronominal usages**

- | | | | | | |
|------|------------|-------------------|----------------|-------------------------|---------------------------|
| (a). | n | kuliya | ŋ | kuliya | |
| | 1SG | go-PST | | ‘I have gone’ | |
| (b). | n | ba | cheche | m | bacheche |
| | 1SG | ride-PST | bicycle | | ‘I rode a bicycle’ |
| (c). | n | faaya | ŋ | faaya | |
| | 1SG | escape-PST | | ‘I have escaped’ | |

From the above, one can observe a widespread occurrence of assimilation of nasal sounds to the places of articulation of adjoining consonants. In the first set of data (51), possessive nasal consonants consistently assimilate to the place of articulation of the following consonants and the same is true for (52) which exemplify various usages of the first-person pronominal form.

2.6.1.2 Vowel Harmony

The issue of vowel harmony has been discussed in various languages by various linguists in the world. In discussing vowel harmony, Goldsmith (1990, p.304) opines that a vowel harmony is a system in which the vowels of a language are divided into two (or more) (possibly overlapping) subsets with the condition that all vowels in a given word (or domain, generally) must come from a single subset. Katamba (1989, p.211; Musah, 2010, p.88) also refers to it as a process whereby within a certain designated domain, usually the word, and all vowels are required to share one or more phonological properties. Usually the vowels of a language are divided into two mutually exclusive sets and all vowels within a stipulated domain must be, say, either front or back, high or low, rounded or unrounded, among others. In the words of Kenstowicz (1994, p.347), vowel harmony is “a phonological state in which the vowels in a given domain harmonise for a particular feature.” To this end, Bodomo also refers to it as a kind of “co-occurrence restriction involving contiguous and non-contiguous vowels” (Bodomo, 1997, p.10) in the organisation of words.

Atipoka and Nsoh (2018, p.3) discussed vowel harmony in the Gurene. According to them vowel harmony is a phonological process in which the vowels in a given domain share or harmonize for a particular feature. Data for this study was collected through recording of utterances of twelve native speakers from six Gurene communities in the upper east region of Ghana. The study source of secondary data was also from Gurene

dictionary, glossary and student works at the department of Gur-Gonja languages Education of the University of Education, Winneba. Various types of harmony in Gurene are discussed in which included vowel harmony, consonant harmony, vowel-consonant harmony, and nasal place harmony. The study employed Autosegmental representation to demonstrate that plural suffixation, loanword adaptation and compounding may be governed by vowel harmony.

Hudu (2010) discusses this type of harmony in Dagbani. The approach he adopts in that study is to describe the harmony between the vowels in Dagbani words with respect to the position of the tongue root, i.e., whether the vowels are produced with an advancement or retraction in the position of the tongue root. Advanced tongue root [+ATR] implies the vowel sound in question is produced with the root of the tongue pushed forward while the un-advanced (retracted) tongue root [-ATR] vowels are produced with the root of the tongue drawn further back from the normal position of the tongue. According to Hudu (2010 & 2015), Dagbani has ten (10) short vowels and five (5) long vowels. He grouped them into two classes a [+ATR] which is class I and [-ATR] as class II as shown below;

Class I vowels [+ATR]: i i: e e: o o: u u: ə

Class II vowels [-ATR]: ɪ ɛ ɔ ʊ a a:

Based on this distinction, the vowels which occur in a word will usually be selected almost exclusively from only one of the sets and not from the two sets at the same time. This phenomenon is reported in many mabia languages such as Dagaare, Gurene, Nankane and Dagbani. (Abubakari, 2018; Atipoka & Nsoh, 2018; Bodomo & Abubakari, 2017; Hudu, 2010, 2015; Apeligila, 2015; Musah, 2010).

2.6.2 Syllable Structure Processes

As regards the syllable structure, Dagbani is among the languages that mostly prefer open syllables to closed ones. The few syllables that have codas usually have nasals in the coda positions or the lateral /l/. Also, syllabic nasal does occur in Dagbani. This has been confirmed by Olawsky (1999), Hudu (2010), Abdul-Rahaman (2013) that the Dagbani syllable structure allows coda positions to be occupied by /m, l, ŋ and n/ as in CVVN words and a few number of CVN. Dagbani also exhibits word internal coda positions. The segments that are allowed in word internal coda positions are: /m, n, m, ŋ, l, b, r, and ʏ/ as in words like ‘gbangu’ (a thick bush), ‘bimbali’ (a tributary of a river) and ‘kulpala’ (fisherman) to mention a few. Following Olawsky (1999), segments that occur in word final position in Dagbani are: /m/ and /ŋ/. For instance, in words like: kpam (oil) dam (shake), and kpaŋ (guinea fowl) and daŋ (family). Dagbani has vowels that occupy initial position. Vowel initial words in this language are either loan words or interjection and not lexical items. Such items begin with vowels such as [a, e, i and o]. These four vowels do occur without consonantal onsets mostly in loan words.

Olawsky (1999, p.161) identifies seven syllable types in Dagbani, namely CV, CVN, CV: I, CVC, V and VC. I observe that the VC syllables identified by Olawsky are either the loans or the interjections as confirmed by Abdul-Rahaman (2013). It is observed that the V (vowel) syllables are personal pronouns; /a/ and /o/. As stated in the above, these four vowels do occur in Dagbani on the onsets without consonants having to be onsets only when they are mostly loan words as said earlier. Some of the words they occur include; ‘imaani’ (generous), from Arabic, ‘ofisi’ (office) from English, ‘abe’ (palm nut) from Akan, ‘adaka’ (box-SG), ‘anabi’(prophet-SG), ‘iin’(yes), ‘ata’ (three), ‘o’ (he, she, it pro.3SG), ‘Itali’(Italy) from English, a’ (you-

2SG), ‘Amarika’ (America). Moreover, a syllable can also compose of only a nasal consonant. In Dagbani the first person pronoun is a syllabic nasal; /n/ which has allophones of /m/ or /ŋ/ depending on the place of articulation of the segment that follows it. However, in Dagbani the palatal nasal /ɲ/ never functions as a syllabic nasal. In summary, complex onsets do not exist in Dagbani but simple onsets do within a single C just as complex codas are marked relative to simple ones.

The most common syllable structure processes in Dagbani induced by morphological process include apocope, the omission of final segment of a word, and syncope, the omission of segments within a word. Similarly, the adaption of loan words into a language also results in segments insertions. For Kuubezelle (1994) these processes affect the basic syllable structure of words in a language by altering the syllable shape of words. The syllable structure process discussed under this section is Elision.

2.6.2.1 Elision

According to Abakah (2004), elision is a “phonological process by which a vowel, consonant and sometimes a syllable, which is an intrinsic property of a morpheme in an isolated style is dropped in a combinative style”. Elision as a phonological process, usually occurs in many languages to ensure that phonology structures conform to the language’s phonotactics. In many languages, different mechanisms are employed to resolve vowel hiatus. However, in Yoruba, large data has shown that deletion is a widely attested strategy for hiatus resolution in the language (Pulleblank & Olanike, 2002; Nindoo, 2017, p.36).

Also, (Abdul-Rahman, 2013) states that vowels, nasal consonants and syllables are all capable of getting deleted and in one of the productive cases of elision found in Dagbani is in plural formation and he analyzed his data using Autosegmental theory.

However, instances of CC clusters resulting to segment deletion was not captured in (Abdul-Rahman, 2013) especially considering loanwords into the language. This will be captured in this thesis and the theory to be used is Autosegmental phonology since it can best be used as a tool to account for elision in the language. Abdul-Rahman (2013) observed that morphological phenomena in a form of compounding are what motivate elision in Dagbani. He mentioned instances of compounding in a form of noun + noun, noun + adjective and in some instances, verb + verb as the triggers for elision in Dagbani. Though this data is mainly on this form of compounding those results in segment elision, he noted that elision is a morpho-phonological process. The present study also used Autosegmental Phonology (Goldsmith, 1976) to account for how elision occurred in nominalization in Dagbani.

As stated above, elision, in Dagbani, takes the form of apocope; that is, the omission of final segment of a word and syncope, the omission of segments within a word. This commonly occurs in word compounding and affixation processes during which a vowel a consonant or a full syllable is elided when two stems are put together or an affix attached to a stem form a new word.

2.6.2.2 Epenthesis

Epenthesis is generally seen as one of the strategies employed in the study of syllables that ensure that the syllables in a language are well-formed. In the present study of nominalization, some word formation undergoes a phonological process of epenthesis. In the study what seemed to undergo epenthesis is the vowel /i/. In the literature, the vowel /i/ is referred to as the schwa /ə/ by Olawsky (1999) and refers to as /i/ in Hudu (2010). It is important to note that both studies agree to the existence of epenthesis in the language. It is observed by the earlier researchers that the nasal

consonants /n/, /m/, /ŋm/ and /ɲ/ in Dagbani can be used as epenthetic segments in the reduplication of CV verbs.

In discussing the nasal consonant epenthesis in Dagbani, Issah (2011) avers that the epenthetic segment forms part of the reduplicant. He argues that the reduplicant requires a moraic size of two moras in order to be qualified as a reduplicant. However, instead of nasal insertion, vowel insertion could have been done to satisfy the moraic requirement but that will yield a wrong reduplicant. This study was carried out to account for the reasons for the presence of the nasal segment in CV verbal reduplication in Dagbani.

In using the Optimality theory (OT) to account for the syllable structure processes in Dagbani, Nindoo (2017) posits that epenthesis and elision are the two prominent phenomena in syllable structure processes. This study investigates the use of epenthesis and elision to ensure well-formed syllables in Dagbani. The work focuses on how segments are epenthesized or deleted in syllables to ensure they are well-formed in the phonotactics of the language. He indicates that in the study of syllables, there are different strategies employed to ensure that the syllables in a language are well-formed. Epenthesis and elision are two of those strategies together with glide formation and coalescence. Dagbani ensures syllable well-formedness by epenthesizing or eliding vowels and consonants in syllables that do not fall within the phonotactics of the language. He showed with relevant data how the vowel /i/ and other consonants are inserted in some Dagbani words as well as loan words into Dagbani to break consonant cluster (CC).

2.7 Chapter Conclusion

This chapter discussed general concept of nominalization drawing data from some languages. It also examined the theoretical frameworks to the study as well as review of related literature relevant to the study. The chapter also discussed some linguistic processes such as morphological and phonological processes in Dagbani. The morphological processes discussed are affixation, compounding and reduplication whilst the phonological processes identified in the study include homorganic nasal assimilation, vowel harmony, elision and epenthesis.



CHAPTER THREE

METHODOLOGY AND RESEARCH DESIGN

3.0 Introduction

This chapter discusses the research methodology. The section deals with the various strategies that the researcher employed to collect the data for a successful study. The data chapter includes; the research design, area of the study, study population, sample and sampling procedures and tools for data collection and data analysis. Methodology is one of the important factors in determining the success or otherwise of every research. This simply refers to the processes and procedures employed in collecting and analysing data. This section therefore discusses the procedures used in collecting and analysing the data for the study.

The composition of the chapter is segmented as follows: section 3.1 discusses the research design and the research approach by providing reasons why such an approach has been considered in the current study. Section 3.2 presents an overview of the data type and the data collection procedures the researcher used in the study. The rest of the sections include 3.3, which presents the area of the research, section 3.4 presents the population, sampling procedure and sample size presented in section 3.5. Section 3.6 discusses the instruments used in the data collection. Sections 3.7, 3.8 and 3.9 respectively discussed procedure for the analysis of the data, the accessibility of the data and the participants used as well as the ethical issues for the study respectively. The conclusion of the chapter is presented in section 3.10.

3.1 Research Approach and Design

The research approach used for the study is a qualitative one. This kind of research approach according to Dörnyei (2007, p.129), “involves data collection procedures

that result primarily in open-ended, non-numerical data which is then analyzed primarily by non-statistical methods". By this, it is a means of describing events without the use of numeral data (Best & Kahn, 2006). The qualitative research approach is mainly descriptive in nature. The process of research involves emerging questions and procedures, data typically collected in the participant's setting and then analyses inductively. (Best & Kahn, 2006, Creswell, 2013). The qualitative research design (Ethnography) is used to collect the data. The ethnographical design shows an in-depth description and interpretation of cultural patterns and meanings within a culture or a social group. For Creswell (2009), ethnography study is done in natural settings over a long period of time by collecting observational and interview data. In the study, observation and semi-structured interview were part of my data collection instruments. According to Chambers (1985) cited in Ochieng (2013), to get a detail information on a particular phenomenon, the qualitative approach is the most appropriate option. The data collection procedures used in this kind of research includes elicitation, and observations. In this study, I employed elicitation, observation and recordings, as well as relying on both published and unpublished materials as methods in collecting the data. The researcher went directly to the research area of his interest to observe and collect the data.

The approach was found to be most suitable for this study because data was elicited naturally. This process made it possible to help minimize bias when the researcher gathered adequate and relevant information for the study. That is to say it prevents the researcher from going to the field with a preconceived mind on the type of data to be collected.

3.2 Data Types and Data Collection Procedures

In this study, two main types of data were collected; these were primary and secondary data. Data is called primary if it is collected by the researcher for the first time under controlled conditions, and data become secondary when the data are already collected by a third party other than the researcher which the researcher relies on for analysis of the study. (Creswell, 2014). The primary data were collected through recordings from free speeches such as radio programs, advertisements, songs from native speakers. These consisted of spontaneous utterances made by these native speakers as they interacted with me and among themselves at naming ceremonies, at work place and other social gatherings. I took note of the discourse taking into consideration the interests of my study.

Secondary data were also sourced from available written texts such as Abu-Bakari (1980 & 1988), Olawsky (1999), the Dagbani Orthography Guide (2004), Mahama (2004), Blench (2004) and Adam (2007).

3.3 Area of Study

Dagbani speaking people are spread across the length and breadth of Ghana but majority of them live in the Northern region occupying seven districts, two municipalities and a metropolis. The field research was conducted in Yendi and Gushegu traditional areas. The researcher chose these places because they are among the towns where the indigenous and custodians of the language is spoken. Below is a map Ghana showing area where the language is spoken.



Figure 1: Language Map of Ghana:

The area marked red is area where Dagbani is spoken. The map is adopted from Lewis et al. (2016)

3.4 The Study Population

Population “is the totality of all subjects that conform to a set of specifications, comprising the entire group of persons that is of interest to the researcher and to whom the research results can be generalized” (Polit & Hungler, 1999; Ziblim, 2018,

p.44). According to Dörnyei (2007, p. 96) population refers to “the group of people whom the study is about”. In other words, population is the group of persons the researcher intends to generalize the findings of his or her research on. In the view of Anggraeni (2011), population is seen as the group of persons with determined characteristics. The population for the study was speakers of Nayahili in the Northern region of Ghana. The participants were drawn from two indigenous Dagbani Nayahili speaking communities, namely; Gushegu and Yendi because these communities are indigenous homes of the Nayahili speakers of Dagbani, the dialect chosen by the researcher.

Based on reports on the 2010 population and housing census conducted by Ghana statistical service (GSS), a body nationally mandated to collect and keep data on the population and the demography of Ghana, the total population of Northern region is about 2, 479, 461. Of this figure the native speakers of Dagbani are around 1,160,000, and the total population of the research area (Gushegu and Yendi) is about 111,259. As stated earlier, it is estimated that over two million people could speak Dagbani in the Northern region. The reasons being that the language is the dominant medium of communication in the region, and it is also taught in schools at all levels and it is also the only northern language spoken on both national television and radio.

3.5 Sample and Sampling Procedure

Dörnyei (2007, p. 96) defines a sample as “the group of participants that are actually examined in a study.” Boateng (2015) cited in Ziblim (2018, p.41) asserts that, sampling is viewed as the “process of selecting samples from a group or population to become the foundation for studying a population in order to obtain data to address a research problem.” Purposive sampling method was adopted in the selection of

participants for the study. Purposive sampling is a sampling procedure used in selecting respondents with the purpose of the study in mind. Here, participants are not chosen at random, they are rather chosen at the researcher's own discretion or judgment because the researcher believes they exhibit special qualities such as having expert knowledge on the subject being investigated, and including them in the sample will enable them provide the right information needed by the researcher. For this reason, the researcher has adopted a purposive sampling technique to enable him gather accurate data that would go a long way to provide a comprehensive analysis to the research questions. It also cost and time-effective since limited number of respondents are used.

A sample of sixteen (16) male and female respondents were selected for the study; eight each from Gushegu and Yendi. Out of this number twelve (12) of the respondents were males and four women with their ages ranged between 18 and 50 years. I decided to include five persons who are either 55 years or above as my language consultants to help me verify some of the data I got from the field. Respondents were chosen based on their knowledge of the language, accessibility and readiness of the respondents, and their academic background; two (2) Senior High School Students, four (4) Junior High School teachers, four (4) Senior High Teachers, four (4) Senior High Leavers, two (2) level 400 University Students who were doing their intensive programme. This was to ensure that the data collected were rich, accurate, reliable and useful for the study.

3.6 Instrumentation

In this study, four (4) data collection instruments were used: elicitation, observation, documents and native speaker's intuition.

3.6.1 Elicitation

Ochieng (2013, p.36) says that elicitation refers to the “process of gathering linguistic data by asking native speakers of a language to produce words, phrases, clause or sentences that can be used as data for analysing a particular linguistic phenomenon.” This study employed direct elicitation as a way of getting data by interacting with native speakers in a natural environment such as the home, market, workplace and schools. Since this study investigates some aspects nominalization in Dagbani, the researcher employed an unstructured form of wordlist and interview(s) to elicit data from some of the respondents. The researcher employed these data collection methods because it is more natural and the data are gotten directly from the participants and not through a third party. In view of this, the following were some of the criteria I used;

Elicitation questions 1a:

(1a). **Question:** **Wula ka yi booni nun bari wahu?**
‘how do you call a person who rides a horse?’

Responses: **O nyɛ la waribara**
3SG be FOC horse rider

‘She/he is a horse rider’.

(1b). **Question:** **O lahi mali yu shɛli?**

‘Is there any other way she/he can be called?’

Responses: **O nyɛ la waribarili**

‘She/he is a horse rider’.

Elicitation questions 2:

In Dagbani, how do you call a horse used for riding?

Question: **Wahu maa nyɛ la waribarili**

Responses: 3SG DET be FOC horse riding

‘It is a riding horse’. ‘A horse used for riding’

The above-mentioned criteria were used to elicit for the data along with the informal way of eliciting data (spontaneous utterances) I needed for the thesis.

3.6.2 Focus group Discussions

Another instrument used in the data collection is the Focus group discussion (FGD). It is “a qualitative research in which a group is identified and involved in a discussion that will elicit their perceptions, opinions, and beliefs towards certain issues” (Kombo & Tromp, 2006; Ochieng, 2013 p.36). Dörnyei (2007; Gariba, 2017, p.44) views focus group interviews as interviews that involve a small group of members usually between six (6) and twelve (12) where the interviewer asks the members questions and records their responses. Here, the participants are made to engage in in natural setting talking freely with one another without any problem by sharing personal experiences, engaging in topical issues such as Chieftaincy, politics, teenage pregnancy, low standard in education, health, agriculture, flooding and high unemployment rate in northern Ghana. Whilst the participants engage in the discussions, the researcher served as a moderator to ensure that the discussions are not hijacked by a few people in the groups.

In this study, a sample of twenty (10) respondents were put into two (2) groups of ten (5) members each. One group was found in each of the two communities under investigation. Each group was made to tell stories, describe activities and events in their community, as well as discuss social issues such as agriculture, education, health, sports and marriage. These discussions took thirty minutes (30) to forty-five (45) minutes each, and the discussion were audio-recorded a long side taken notes. A digital recorder was used to record the discussions. The recordings were then played later in a quiet environment and all lexical items were identified and transcribed for analysis.

I employed this data collection method because it is an economical way to gather a relatively large amount of data. It is also more natural and the data is got directly from the participants and not through a third party. It is also flexible and can be adjusted by the researcher based on the group attitude.

3.6.3 Observation

Observation was another method that was used to obtain information on the study. Observation is also seen as one of the essential tools in research. Observation is defined as the “systematic, purposeful recording of interactions and events in classrooms (Bailey, 1999; Owusu, 2017, p.57).

The purpose of the observations was to find out how nominals are derived and used. This type of instrument was an informal one used at social functions/gatherings such as naming ceremonies, schools, weddings and at the workplace with colleague teachers.

I visited some schools and during lesson delivery by teachers, the researcher placed himself in a way that enabled him to see and listen to whatever went on between the teachers and the students. During break and other out-of-lesson activities, the researcher listened to the use of words, phrases or clauses made by teachers and students in their conversations. Here, particular attention was paid to how nominals were created and used from other grammatical categories.

The researcher also listened to the language used by native speakers both literate and non-literate alike with reference to deriving of nominals at funerals, markets, naming ceremonies, weddings and youth meetings. These words, phrases or clauses were

collected and put according to the various nominalization processes, types and strategies and later analysed.

3.6.4 Documents

This is a way of getting data by picking information from existing written documents. Arikunto (1998) in Anggraeni (2011) and Gariba (2014, p.41) refer to it as a “method of data collection by studying books, transcriptions, newspapers, advertisements, magazines among others.” The written documents I sourced information included the Dagbani Orthography (2004), Dagbani-English Dictionaries by Blench (2004) and Mahama (2004) and Dagbani Grammar by Abu-Bakari (1980), Dagbani word classes by Abu-Bakari (1988), some word formation processes in Dagbani by Adam (2007) and aspect of Dagbani grammar by Olawsky (1999).

3.6.5 Researcher’s Native Intuition

As a speaker of Dagbani, I relied on my native intuition to gather some of the data for the study. I constructed sentences and phrases concentrating on the core part of the thesis, nominalization. In some of these sentences and phrases the occurrence of some word classes led to the deletion of some segments to ensure well-formedness. In other instances, segments were inserted while others went through assimilation processes to ensure well-formed syllables in the language. Also, in public places or at home where I interacted with speakers, I used my intuition as a speaker to get some data that are relevant to this work. My native speaker’s intuition therefore was one of the major sources for data for this work.

3.7 Data Analysis Procedure

After collecting the data using the data collection procedures mentioned earlier, the voluminous data were categorized into groups based on the various morphological

processes, that is, reduplication, compounding and affixation. A variety of words, phrases, clauses and sentences were produced by the participants which contained words, some of which demonstrated nominal derivational processes. It was then realized that some of the words that participants released were words derived from some of the major word classes such as verbs, adjectives and nouns. The nominals were created through derivation, some compounding while others came from reduplication and affixation. Though the number of participants for the study was quite small as compared to the many speakers, data from secondary source complemented the primary source of data collection and that the objectives were to demonstrate that nominalization exists in the language through certain processes.

All the morphological and the syntactic processes as well as the semantic properties in nominalization were discussed and accounted for. The discussions and analysis were done using the Basic Linguistic Theory (Dixon, 2009, 2010 and 2012) and the Autosegmental phonology frameworks (Goldsmith, 1976) as stated in chapter two.

3.8 Accessibility

The researcher resides in Tamale about 106 kilometers away from the research area, but a native of the research area. The researcher made four trips to each of the two communities (Gushegu and Yendi). The researcher embarked on a maiden trip to find respondents and familiarize with them. This was done with the help of my younger brother, Muzamil and my childhood friend, Mr Abu who happened to be an assembly member in one the electoral areas in Yendi. The elicitation of data was done on both face-to-face and by mobile phone calls and the observation was done throughout the data collection and analyses period.

3.9 Ethical Consideration

In conducting a research of this nature, it was imperative to consider ethics. Ethics is all about questions of right and wrong. For this reason, a researcher must ask the relevant questions if it is right or wrong to investigate a certain phenomenon. The chapter also highlighted how the researcher was able to mitigate the issues of research ethics of the study. The researcher sought consent from the respondents by providing consent forms to the research participants before the study commenced. It has also indicated how the confidentiality and privacy of the participants were respected throughout the study. In this study, the researcher considered all research directives by maintaining confidentiality, openness, honesty, responsibility as well as seeking permission from the required offices and officers. To this, the researcher was able to build trust among the respondents in the field which then helped to mitigate unnecessary distress, fear and harm among respondents.

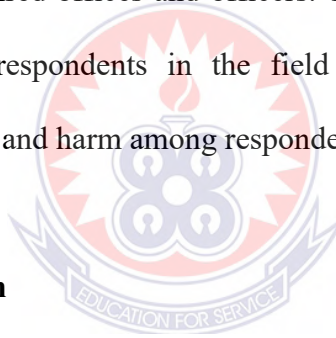

3.10 Chapter Conclusion

The chapter discussed the sources of data, data collection strategy and how the research was carried out. The objective was to investigate how nominals are derived in Dagbani, the functions of the derived nominals and the types of nominalization used in the language. It also considered the methods and procedure followed to answer the research questions posed in the study. The chapter was discussed in the following order: research design; the area of the study; population for the study, sampling procedures for the study; data collection instruments; data analysis plan. Finally, this chapter has shown how participants' rights were respected throughout the study.

CHAPTER FOUR

DATA PRESENTATION AND ANALYSIS

4.0 Introduction

In this chapter, analysis of the data collected is presented. This study set forth to investigate some aspects of nominalization in Dagbani. Specifically, the study set out to do three main things; to look at the types of nominalization in Dagbani, to identify some linguistic processes (morphological and phonological) that the language employs to derive the nominal and finally, to look at syntactically, the functions of the derived nominals in Dagbani.

The data on various nominalization processes which have been classified into three categories, namely; compounding, affixation and reduplication, have been analyzed. The data collected also discussed nominalization strategies and types; action and participant and have been analyzed. The analysis is done from linguistics perspective using the frameworks of Basic Linguistic Theory (BLT) proposed by Dixon (1997, 2009, 2010 & 2012) and the Autosegmental phonology (Goldsmith, 1976) to provide answers to the research questions outlined in chapter one. The study of nominalization has attracted many linguists around the world. Nominalization plays very important role in enriching lexical nouns. All languages globally have nouns formed by nominalization process but they may have different ways of deriving nominals.

Thus far, in this chapter, the data for the study are presented and discussed. The chapter is grouped into four sections. Sections 4.1 and 4.2 respectively present analyses on action and abstract nominalization through morphological means of affixation, compounding and reduplication. The chapter also contains a discussion on the syntactic functions of the derived nominal. Sections 4.3 to 4.9 focus on other types

of nominalization identified in the study which include agentive, patient, locative, instrument, product, manner as well as experiencer nominalizations. Section 4.10 discussed some key phonological processes that are observable in deriving nominals in Dagbani using the Autosegmental phonology representation. The conclusion of the discussion on the types of nominalization, the linguistic processes of nominalization which include, morphological structures and some phonological processes and some syntactic functions of the derived nominals in Dagbani are outlined in section 4.11.

Due to the relatedness of the issues regarding the objectives and the research questions set forth to analyse the data in this study, it would be difficult if not impossible to separate the issues in the data analysis. For this reason, in this chapter the research questions are answered together. The chapter focuses on the types of nominalization identified in the study, it also followed by the various morphological strategies or processes Dagbani employs to form nouns. Some phonological issues identified in data and the syntactic functions of the derived nominals were equally discussed. In addition, data would be drawn from the analysis in section 4.10 to account for the phonological processes identified in the study using the Autosegmental phonology representation.

4.1 Action Nominalization in Dagbani

Action nominalization is one of the nominalization types where the resultant nominal is semantically action-oriented (Jeremiah, 2005, p.18). That is the nominal denotes the action of the verb. Action nominalization in Dagbani involves attaching a suffix to the verb root or stem. In this process, the suffix nominalizers are attached to verbal roots or stems which change such verbs from their original class/status to a noun. As far as this study is concerned, what is evident to be the only highly productive strategy in nominalization in Dagbani is the morphological strategy. The morphological strategy

of nominalization employs certain morphological or word formation processes such as affixation, compounding, reduplication among others to form new words. The morphological process used in this method is affixation. Different types of affixes come into combination with the verb stem to derive the action nominals.

4.1.1 Action Nominalization through Affixation

This section discusses action nominalization through affixation. It is interesting to note that action nominalization employs only one common nominalizer **-bu** and its allomorph **-bu** to form nominals. The suffix and its allomorph are suffixed to the bare forms of verb. The choice of the **-bu** or **-bu** is determined by the ATR feature of the verb root. Whereas **-bu** with the [+ATR] vowel attaches to the verb roots, **-bu** with the [-ATR] vowel attaches to the verb roots with [-ATR] as the following examples in table 1 shows.

Table 1: Verb-suffix action nominals in Dagbani

Verb	Gloss	Nominalization	Gloss
a) zo	‘run away’	zobu	‘the act of running away’
b) teei	‘remind’	teebu	‘the act of reminding’
c) pooi	‘rot’	poobu	‘the act of being rotting’
d) pii	‘select’	piibu	‘the act of selecting’
e) payi	‘wash’	payibu	‘the act of washing’
f) ηme	‘knock’	ηmebu	‘the act of knocking’
g) lihi	‘look’	lihibu	‘the act of looking’
h) kōhi	‘sell’	kōhibu	‘the act of selling’
i) ku	‘kill’	kubu	‘the act of killing’
j) guui	‘run’	guubu	‘the act of running’
k) gbihi	‘sleep’	gbihibu	‘the act of sleeping’
l) gbaai	‘catch’	gbaabu	‘the act of catching’

As can be seen from the table 1 above, the morpheme -bu is attached to some verbal roots to derive nominals. This action nominalizer is one of the productive nominalizing suffixes in Dagbani. This suffix usually describes an action or process. Also, verbs that have the structure CV: V, have to delete or drop the final vowel /i/ when the suffix is attached to the verb. There is one major phonological process that occurs in the process of forming the action nominals, which is worth noting. Whenever the verb stem ends with a front unrounded high vowel and the preceding syllable has a long vowel V: as seen in Table 1 (b, c, j and l), the final front unrounded high vowel is elided before the nominal suffix -bu is attached.

4.1.2 Action Nominals Formed from Reduplicated Action Nominals

The data revealed that some action nouns may be reduplicated to derive other action nouns in the language. The meaning of the reduplicated action nominal may not be different from the original (derived) action noun. It however indicates that the reduplicated nouns may convey additional connotation in the minds of the speakers to denote intensity or the frequency of the action. The data in Table 2 below illustrate the observation.

Table 2: Reduplicated derive action nominals

Action Nominal	Gloss	Reduplicated form	Gloss
a) kpibu	‘death/dying’	kpibukpibu	‘frequency of the action death/dying’
b) dabu	‘buying’	dabudabu	‘frequency of the action buying’
c) zubu	‘stealing’	zubuzubu	‘frequency of the action stealing’
d) chandi	‘walking’	chandichandi	‘frequency of the action walking’
e) nyɔbu	‘burning’	nyɔbonyɔbu	‘frequency of the action burning’
f) zabili	‘fight’	zabilizabili	‘frequency of the action fight/fighting’
g) ɲarili	‘cheating’	ɲariliɲarili	‘frequency of the action cheating’

As seen in Table 2 above, the derived action nominals have been totally reduplicated in the resultant action nouns. Generally, the derived nominals have identical meanings to their simple forms, as the examples in table 2 illustrate. For instance, both **zubu** and **zubuzubu** index ‘stealing’ except that the reduplicated nominal expresses repetition/frequency of the action ‘stealing’. This observation is confirmed in Asante (2018) and Bomanchihi (2012) for Nkami and Dagaare respectively.

4.1.3 Action Nominals derive from inherent complement verbs through affixation

In many languages, particularly Kwa languages such as Lete (Akrofi, 2012), Igbo (Nwachukwu, 1985), Akan (Osam, 1996), Nkami (Asante, 2018) and Asante- Twi (Appah, 2005) there are several verbal concepts that are expressed through what is termed as “inherent complement verbs” (ICVs).

In Dagbani, an action nominal can be formed not only through affixation and reduplication but can also be derived through a multiple derivation (compounding and affixation). With this type of morphological strategy, there is a re-ordering of the constituents of a verb phrase and compounding. Verb phrases that undergo the process are made up of a transitive action verb and its internal argument. In the resulting compound, the argument precedes the action verb. This process is also referred to as “reversal of inherent compliment verb” (Asante, 2018, p.12). It consists of a verb and its object by reversing the order of the verb and the object. Considering the order of derivation, -bu is suffixed after the verb and its inherent complement have been compounded. Consider Table 3 below;

Table 3: Verb-Noun+ Suffix derived action nominals in Dagbani

Verb	Noun	Nominal	Gloss
a) di eat	sayim TZ	sayim dibu	‘the act of eating TZ’
b) wa dance	waa dance	waa wabu	‘the act of dancing/dancing’
c) duyɪ cook	sayim TZ	sayim duyibu	‘the act of cooking TZ’
d) duhi ‘drive’	loori ‘a car’	loori duhibu	‘the act of deriving (a car)’
e) ba ‘ride’	cheche ‘bicycle’	cheche babu	‘the act of riding a bicycle’
f) pini ‘shave’	zuyu ‘head’	zuyu pinibu	‘the act of shaving the head’
g) pini ‘shave/trim’	tia ‘tree’	tia pinibu	the act of trimming a tree’ ‘trimming (of) tree’
h) nyu ‘drink’	dam ‘alcohol’	dam nyubu	‘the act of drinking alcohol’
i) tum ‘do’	tuma ‘work’	tuma tumbu	‘working’

This form of strategy is not found only in Dagbani but some other languages across the world. (See Asante, 2018, p.12; Akrofi-Ansah, 2012 & Appah, 2005). As we have seen in table 3 above, the composition of most ICVs consist of a general verb and a nominal complement that relates to the meaning designated by the whole ICV. For instance, in Table 3 the semantic content of the complement, **danyubu** ‘drinking (of) alcohol’, **tuma tumbu** ‘working’ and **waa wabu** ‘dancing’ relate to the combined meaning of the ICV **nyu dam** ‘drink alcohol’, **tum tuma** ‘do work’, and **wa waa** ‘dance a dance’ respectively. The verb phrases are turned into action nominals by reversing their lineal order such that the complements precede the verbs in a compound.

4.1.4 Syntactic functions of the Derived nominals

In this subsection of the study, we look at the syntax of the derived nominals with regard to where they can occur within the sentences. Derived nouns possess some morphosyntactic characteristics which are common to prototypical nouns.

Syntactically, action nominals may function as subject, object, an indirect object or a possessor. In this subsection we show the various syntactic positions within which the derived nominal may function. This serves as one way of proving the nounness (the nature or quality of a noun) of the derived nominal. It also serves the purpose of giving us a standard against which we judge the syntactic behaviour of the derived nominal relative to the verb from which it was derived.

4.1.4.1 Action Nominals as Subjects

The derived action noun may function as subject of a clause as found in (1), and object as demonstrated in (2).

- (1) (a) **kuriginsim ka/sheei Limam na.**
 old age come/arrive Limam DEIT

‘Limam has attained/reached old age.’

- (b) **kobu nye la anfaani tuuni**
 farming be COP FOC important work

‘Farming is a good occupation.’

- (c) **layingu maa ziini-la yim yuuni kam puuni**
 meeting DET sit PROG once year every inside

‘The meeting takes place (comes off) once in every year’

- (d) **karimbu saṅdi shikuru bihi**
 reading help.HAB school child-PL

‘Reading helps students.’

4.1.4.2 Action Nominals as Objects

(2) (a). **Jahima je di-bu**
 Jahima NEG.like eating-NOM

‘Jahima does not like eating.’

(b). **Khadijah je duu kolibu**
 Khadijah NEG.like room sweeping

‘Khadijah does not like sweeping.’

In the above examples (1 & 2), it can be seen that the action nominals can function as a subject and as an object. This confirms in the literature that an Action Nominal may function as an argument of a verb within the sentence structure (see Asante, 2018; Ofori, 2014 & Akrofi-Ansah, 2012).

4.1.4.3 ANs as possession

Furthermore, in an alienable possessive construction, a derived nominal which is non-relational may function as a possessed noun as illustrated in (3).

(3) (i). **Tiyumba sabbu bi viela**
 Tiyumba writing NEG good

‘Tiyumba’s writing is bad.’ (‘Tiyumba’s handwriting is bad.’)

(ii). **Nindoo dibu ka jilima**
 Nindoo eating NEG respect

‘Nindoo’s (way of) eating is bad.’

A derived action nominal (AN), may also take modifiers including determiners (1c) and quantifiers, as (4) illustrates accordingly.

4.1.4.4 Action Nominals take quantifiers

- (4) (i). **dibu pampam ka alaafee**
 eating much NEG health
 ‘Too much of eating is not healthy.’
- (ii). **karimbu pampam yoori fahim**
 reading much open intelligence
 ‘Extensive reading broadens one’s knowledge.’

4.1.4.5 ANs and pluralization/plurality

At the level of morphology, in relation to the general tendency, action nominals in Dagbani are distinguishable from prototypical nouns in Dagbani. For instance, they cannot be pluralized and for that matter cannot be attached with any form of nominal suffixes in the language, **-hi**, **-nima**, **-ba**, **-si** etc. to indicate number difference as illustrated in following examples (5).

Some prototypical nouns that inflect for the plural suffixes **-ba**, **-hi**, **-a**, **-nima**, **-si** etc.

4.1.4.5.1 The plural suffix [-ba]

		Singular	Plural	Gloss
(5)	(i)	nira	niriba	‘person’
	(ii)	pukpara	pukpariba	‘farmer’
	(iii)	paya	payiba	‘woman’

4.1.4.5.2 The plural suffix [-nima]

(6)		Singular	Plural	Gloss
	(i)	cheche	chechenima	‘bicycle’
	(ii)	karante	karantenima	‘machete/ cutlass’

4.1.4.5.3 The plural suffix [-hi]

(7)		Singular	Plural	Gloss
	(i)	bia	bihi	‘child’
	(ii)	tia	tihi	‘tree’

(iii) **mia** **mihi** 'rope'

4.1.4.5.4 The plural suffix [-si]

(8)	Singular	Gloss	Plural	Gloss
(i)	kpaŋa	'axe'	kpansi	'axe'
(ii)	jaŋa	'monkey'	jansi	'monkey'
(iii)	zɔŋa	'bat'	zɔnsi	'bat'

4.1.4.5.5 Action nominals cannot take the plural suffixes as discussed above in Dagbani.

(9)	(a)	dibu	*dibunima 'eating'
	(b)	chandi	*chandiba 'walking'
	(c)	dabu	*dabunima 'buying'

4.1.4.6 AN as focused NP

The object arguments of the verbs in (10ai & 10bi) are derived nominals which may be proposed for focusing. When the object (derived nominal) is put clause-initially, it is followed by the focus marker **ka** as illustrated by (10a ii & 10bii) respectively.

- (10) (a) (i). **Faridah** **bɔ-ri** **bohimbu**
 Faridah like.HAB learning
 'Faridah likes learning.'
- (ii). **bɔhimbu** **ka** **Faridah** **bɔ-ra**
 learning FOC Faridah like-HAB
 'It is learning that Faridah likes.'
- (b) (i). **Kasuli** **zahim** **zahindi**
 Kasuli dream-PST dream-NOM
 'Kasuli had a dream.'
- (ii). **zahindi** **ka** **Jebebu** **zahim**
 dream.NOM FOC Jebebu dream-PST
 'It was a dream (that) Jebebu had (dreamt).'

4.2 Abstract Nominalization in Dagbani

Abstract nominalization involves transforming a stative or non-action verb to function like a noun. In this situation the resultant nominal has the semantics of the stative/non action verb. That is to say that the phenomenon states the condition or state of the subject or topic. Abstract nominalization can be derived in Dagbani by attaching the suffixes **-sim/-nsim** or **-gu** to a stative verb. Considering the morpheme **-sim** and its allomorph **-nsim**, it is imperative to know that morpheme has the widest representation whilst the allomorph has a restricted environment. For instance **-sim** can occur in CVC(N), CV:, CV:V(i) and CVCV verbs. The allomorph **-nsim** only occurs in environment of trisyllabic verbs which final syllable is /gi/

It is important to note that a stative verb states the condition, and so therefore, there is no real action denoted but indicate abstractness. There is a morphological change in the structure of the stative verbs similar to the ones we saw in action nominalization above. Let us first examine abstract nominals involving **-sim** or **-nsim** suffixes before the **-gu** suffix.

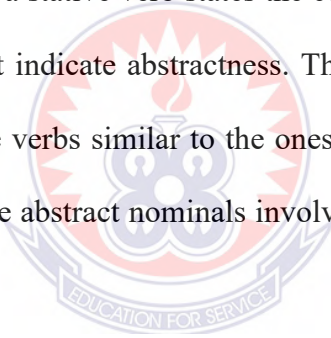

4.2.1 The Suffix [-sim]

This is another abstract nominalizer which is attached to some verb stems to derive abstract nominals. The **-sim** may be attached to a stative verb of any of the following structures: CVC (N), CV:, CVCV and CV:.V as Table 4 exemplifies:

Table 4: Verb-Suffix abstract nominals in Dagbani

Verb stem	Gloss	Nominalization	Gloss
a) baŋ	‘know’	baŋsim	‘knowledge’
b) tam	‘forget’	tamsim	‘forgetfulness’
c) wum	‘be tired’	wumsim	‘tiredness’
d) bii	‘be hot’	biisim	‘heat/ hotness’
e) yuui	‘have long age’	yuusim	‘longevity’
f) yeŋi	‘say’	yeŋisim	‘statement/saying’
g) neei	‘clear’	neesim	‘clarity’

As observed in the data, the examples in Table 4(e & g) have to undergo a phonological process of elision. Here, the final vowels of the verb stems are deleted when the nominalizer **-sim** is attached as a similar observation is made in table 1. The rest of the examples in table 1 have remained unchanged.

The suffix **-nsim** may also be attached to some verb stems to derive nominals. This process does not trigger vowel elision as seen in the case of some words in table 4. These verb stems are trisyllabic in nature with the CVCVCV structure. Below are examples for consideration as seen in table 5.

Table 5: Verb-suffix abstract nominals in Dagbani

Verb Stem	Gloss	Nominalized form	Gloss
a) borigi	‘get lost’	boriginsim	‘being lost’
b) woligi	‘separate’	woliginsim	‘difference’
c) gbarigi	‘become weak’	gbariginsim	‘weakness’
d) tibigi	‘honour/recognize’	tibiginsim	‘honour/recognition’
e) tiligi	‘save’	tiliginsim	‘salvation’
f) kurigi	‘to grow old’	koriginsim	‘old age’

From the table 5 above, it is realized that (a-f) have the same pattern. The verbs are trisyllabic in structure. There is no deletion of syllable or segment of a sort. One observation made in the data is the combination of the verb stem and the nominalizer. For instance, if the final syllable of the verb stem is /gi/, the suffix **-nsim** is attached.

4.2.2 The abstract nominalizer -gu/-go

This is a process that involves verbs taking on the above suffix to derive nominals in Dagbani. The underlying form **-gu** or **-go** is associated with roots structures CVCV or CVCVC(N), where N is the bilabial nasal and the vowels being either [+ATR] or [-ATR] class. Consider the following examples in Table 6.

Table 6: Verb-Suffix abstract nominals in Dagbani

Verb	Gloss	Nominalized item	Gloss
a) mali	‘have’	maligu	‘possession/household’
b) liri	‘attack’	lirigo	‘attack’
c) layim	‘gather’	layiŋgu	‘meeting/ group’
d) vihi	‘investigate’	vihigu	‘investigation/research’

As it is evident from the Table 6 above, it is realized that Table 6(c) has undergone an assimilatory process. The verb that has the CVCVN has to assimilate to change to the place of articulation of the following initial consonant of the suffix from a bilabial nasal to a velar nasal.

Another observation that can be made from Table 6 is that the nominalized forms do not deviate from the vowel harmony rule in Dagbani. In the words, maligu [**maligu**] ‘possession’, [**lirigo**] ‘attack’ and [**layiŋgu**] ‘meeting’ all the vowels belong to the

same class, Unadvanced Tongue Root (-ATR) whilst vihigu ‘investigation’ belongs to the Advanced Tongue Root (+ATR).

Similarly, it is observed in the study that some other verbs can take different abstract nominalizers as discussed above in Dagbani to derive nominals that denote abstractness. These nominalizers are **-m** & **-lim**. When such attachment is achieved, some of the derived abstract nominals undergo some phonological processes such as whole syllable or consonant segment deletion as well as vowel insertion as illustrated in Tables (7 and 8) below.

Table 7: Verb –Suffix derive Abstract Nominals in Dagbani

Verb	Gloss	Nominal	Gloss
a) nyo	smell	nyom	‘smell/stench’
b) to	‘bitter’	tom	Bitterness
c) viela	to be beautiful/good	vielim	‘beauty’/goodness’
d) piela	‘to be white’	pielim	‘whiteness’
e) bala	‘to be soft/smooth’	balim	‘softness/smoothness’

From the data above, it is worth mentioning that, some of derived abstract nominals have undergone final vowel elision. For instance, the final vowel /a/ has been deleted as seen in table (7c – e) whilst the vowel /i/ has been inserted. The phenomenon of elision of any form is highly productive in Dagbani. This confirms the observation made in the literature which shows evidence of elision in the language (See Olawsky, 1999; Abdul-Rahaman, 2013; Nindoo, 2017).

Table 8: Verb-Suffix derive Abstract nominals in Dagbani

Verb	Gloss	Nominal	Gloss
a) waya	‘to be far/long/tall’	wayilim	‘length/tallness/height’
b) bara	‘to be big/large/fat’	barilim	‘fatness/largeness’
c) sabigi	‘to be black/darkened’	sabilim	‘blackness/darkness’
d) jerigi	‘be fool’	jerilim	‘foolishness’

As it is evident from Table 8 (a & b) have their final vowels deleted when the nominalizer was attached to the verbs. Also, table 8 (c & d) experienced final syllable deletion.

4.3 Agent (ive) Nominalization in Dagbani

Agent nominalization is a process that derives a nominal that refers to an agent of a verb. It also refers to the agent indicators of the nominalized verb. Agentive nominalization in Dagbani refers to a type of nominalization that refers to the agent or doer of the nominalized verb. As expressed by Payne (1997), this kind of nominalization is summarized as (V → N Agent of V). In Dagbani available data show that agentive nominalization is very productive. In Dagbani, only evidence of the use of the morphological method is found in the construction of agent nominalization. The agent nominals are formed through the use of suffixes such as **-da**, **-ra** and **-na**. It might be noted that these agent nominalizers also function as verbal affixes (Gurundoo, 2012, p.53). This has been discussed in chapter two. The choice of any agentive nominalizer is largely dependent on the verb stem or root in the language. The data below illustrate the agentive nominalizers in Dagbani.

4.3.1 Agentive Nominals derived from verb stems through Affixation

This type of nominalization uses affixation process to derive nominals in Dagbani.

Different suffixes are employed to attach to verbal stems or roots to realize nominals.

These include the following:

4.3.1.1 The agentive Nominalizer -da

The combinations which result in the transformation of nouns from verbs refer to the one performing the action or the performer of the action by the attachment of the affix. Some of these are exemplified in Table 9 below:

Table 9: Verb-suffix derived agentive nominals in Dagbani

Verb	Gloss	Nominalized	Gloss
a) nam	‘create’	namda	‘creator’
b) sɔŋ	‘help/support’	sɔŋda	‘helper/supporter’
c) chom	‘sabotage’	chomda	‘saboteur’

As evident from the Table 9 above, the derived agent nominals are human nominals derived from non-stative verbs through affixation. It is observed that the choice of the nominalizer has been influenced by a close syllable with nasals at the coda. The derived agentive nominals indicate singular and can also take plurals. The nominals accept **-ba** as the plural marker. In this case, the singular nominals experience final vowel elision and insertion of /i/ before the plural marker is attached to the nominal.

4.3.1.2 The agentive Nominalizer -ra

There are a number of verb stems that take the agentive suffix ‘-ra’. In the formation of nouns of such nature, the suffix is attached to the stem to form the nominal. The examples below demonstrate how verbs are nominalized with the agentive marker ‘-

ra'. The meaning derived from this type of agent nominal is not distinct from the other agent nominals. The verb stems are made up of **CV.CV** and **CV** syllable structures. This is exemplified in Table 10 below;

Table 10: Verb-suffix derived agentive nominals in Dagbani

Verb	Gloss	Nominalized form	Gloss
a) sahi	'sharpen'	sahira	'one who sharpens'
b) she	'sew'	shera	'one who sews'
c) nyahi	'taste'	nyahira	'taster' (one who tastes food)
d) da	'buy'	dara	'buyer'

From Table 10 above the suffix **-ra** occurs in an environment of **CV** and **CVCV** where the final syllable is /hi/.

4.3.1.3 The agentive Nominalizer /-na/

Another agent nominalizer identified in data is the **-na** suffix attached to open syllables. The semantics may inform the choice of the allomorphs by the speakers of the language as illustrated in Table 11 below;

Table 11: Verb-Suffix derived agentive nominals in Dagbani

Verb	Gloss	Nominalized form	Gloss
a) mali	'repair something/make'	maana	'one who repairs/a repairer'
b) yoli	'look after something'	yoona	'caretaker/guardian'
c) pali	'fulfil'	paana	'one who fulfils promises'

As it is evident from the above examples in Table 11 (a - c) have to do away with their last syllables to enable them attract the suffix. The presence of the nominalizer

causes the vowel in the first syllable to lengthen, that is, vowel lengthening. The suffix /na/ is conditioned in an environment where the syllable structure of the verb is CV:CV or CVCV where the final syllable is /li/ as seen in Table 11. This phonological process exists in the language. This phenomenon also exists in Dagaare, a genetically related language. Bomanchihi (2012, p.36) a genetically related language family of the Gur languages observes that some action nominals undergo vowel lengthening to enable suffixes to combine with the stem as illustrated in example 11 below;

11: Derived action nominal in Dagaare.

	Verb	Gloss	Nominalizer	New Word	Gloss
a)	ti	‘hold’	-bu	tiibu	‘act of holding’
b)	vi	‘breakdown’	-bu	viibu	‘act of breakdown’
c)	mi	‘rain’	-bu	miibu	‘act of raining’
d)	le	‘fall’	-bu	leebu	‘act of falling’

The above illustration shows evidence of action nominalization in Dagaare that exhibit vowel lengthening as a phonological process.

4.3.1.4 Agentive Nominals through affixation

This phenomenon involves deriving an agentive nominal from other nouns through affixation of suffixes in Dagbani. This means not only can verbs be nominalized in Dagbani, but also other nouns can also be nominalized through suffixation. There are nominal words in the language which are derived from their bases through suffixation. Some of these suffix-derived agentive nouns are shown in Table 12 below;

Table 12: Noun-suffix derived agentive nominals in Dagbani

Noun	Gloss	Suffix	Gloss	Nominal	Gloss
a) buni	‘riches/wealth’	dana	‘owner’	bundana	‘rich person’
b) nani	‘poor’	dana	‘owner’	nandana	‘poor person’
c) puu	‘farm’	lana	‘owner’	puulana	‘farm owner’
d) liyiri	‘money’	lana	‘owner’	liyirilana	‘rich person’

From Table 12 above, we observe that the agentive nominals derived consist of a base and a suffix. The base of all the words contains either initial lateral or voiced alveolar consonant. As seen in the above data, this process of affixation to derive a nominal from other nouns triggers a final vowel elision of the noun as seen in Table 12 (a & b). However, Table 12(c & d) have remained unchanged.

Furthermore, from Table 12(b & d) above, it can be seen that both words share the same meaning, according to the participants of the study, both words have different connotation. For instance, the word **bundana** refers to a ‘wealthy person’ not only in terms of having physical cash, but also seen as having other valuable assets. However, **liyirilana** is referred to someone who has only ‘physical cash’ at his disposal.

4.3.2 Agentive nominalization through reduplication

Thus far, we have looked at Agent nominals through affixation that are derived from simple verb stems. In Dagbani, it is possible for Agent nominals to be derived from other Agentive nominals through reduplication. The nominalization process has already been observed to apply to [+reduplicative] verb stems. What this implies is that the nominal affix is attached directly to the stems but not to the reduplicants. Below illustrate some reduplication types identified in the data.

4.3.2.1 Agentive nominalization through total reduplication

This is a process that involves nouns also undergoing total reduplication in Dagbani. The data below comprise monosyllabic (CV), disyllabic (CVCV) and trisyllabic (CVCVCV) structures. Here, the derived agent nominals are reduplicated which result in another agent nominal. Some examples are provided in Table 13 below:

Table 13: Noun reduplicated derive agentive nominals in Dagbani

Nominal	Gloss	Nominalized form	Gloss
a) tira	‘giver’	tiro tiro	‘giver/ one who gives’
b) nyara	‘seer’	nyaronyaro	‘seer one who sees far’
c) vihira	‘investigator’	vihirovihiro	‘investigator/researcher’
d) nyihira	‘informant’	nyihironyihiro	‘one who leaks information’
e) daara	‘pusher’	daarodaaro	‘one who pushes things’
f) wuhira	‘director’	wuhirowuhoro	‘one who directs/director’
g) lihira	‘watcher’	lihirolihiro	‘one who cares for/one who watches’
h) chanda	‘walker’	chandochando	‘one who walks’

The above examples show total reduplicated nominal forms. As observed in Table 13 (d - h), there is evidence of raising an open front unrounded vowel to a close-mid back rounded vowel across the above examples given. This confirms a similar observation made in (Adomako, 2012). It must be noted that whenever an agent nominalization/ nominal has a reduplication of the verbal root receiving the nominalizer, this becomes an attitude marker on the nominal, or an intensifier. In Table 13(h) above, the nominal does not only show that the person is the actor of the verb ‘walk’ but also that ‘walking’ is his unpopular habit (an attitude of dislike to this

habit is conveyed by the reduplication). A similar phenomenon is also observed in Olusuba language by (Okumu, 2005, p.26), a Bantu language spoken in western Kenya as illustrated in 12(a & b) below;

- (12) (a). **omu-** + **genda** + **genda** = **omu- enzi- genzi**
 NZR go go ‘habitual walker’
- (b). **omu-** + **gamba** + **gamba** = **omu-gambit- gambit**
 NZR talk talk ‘talkative’

As observed in the above example (12), it shows how verbal roots are nominalized through reduplication of a verb stem. After the reduplication process, the reduplicated forms are attached with a prefix nominalizer to denote an agentive nominal.

4.3.3.1 Agentive nominalization through compounding

This is the process of deriving nominals through compounding. It involves the combination of noun-noun to form another noun. Consider Table 14 below;

Table 14: Noun-Noun Compound Agentive Nominals in Dagbani

Noun	Gloss	Noun	Gloss	Nominalized form	Gloss
a) daa	‘market’	bia	‘child’	daabia	‘a trader (lit. market child)’
b) kariŋ	‘studies’	bia	‘child’	karimbia	‘student’
c) kariŋ	‘studies’	ba	‘father’	karimba	‘teacher’

It is interesting to note that in the data, there is evidence of agent nominalization that may refer to things with reference to characteristic activities or specific events. Some of the agent nominals refer to characteristic or habitual activities while others refer to uncharacteristic or specific activities or events. For instance, **karimba** (‘teacher’) and

daabia ('trader') refer to a person who characteristically engages in teaching or imparting of knowledge as a job or an occupation for a living, not to anyone, for instance, a parent who sometimes helps her kids with their school assignment and the one who habitually engages in buying and selling of goods but not to anyone who goes to the market at specific occasions respectively.

It is important to observe that in the data it revealed that some of the nominals have undergone some phonological process. Table 14 (b & c) above show a homorganic nasal assimilation process during the derivation of the compound nominals. The bilabial-plosive /b/ regressively assimilates the velar-nasal /ŋ/ ending the first word to become a bilabial-nasal /m/. The velar nasal /ŋ/ assimilates to a bilabial nasal /m/ in the environment of a bilabial plosive /b/. These findings are in line with Abdul-Rahaman (2013). The Autosegmental representation will be done in section 4.10.

Asante (2018, p.16) makes a similar observation for Nkami, a genetically unrelated language, and concludes that Nkami shows evidence of both phenomena as some of its agent nominals refer to characteristic/habitual activities while others refer to uncharacteristic or specific activities. For instance, the agent nominals **o-sunapi** 'teacher' refers to someone who is characteristically engaged in teaching as a job for a living, not to anyone, for instance, a parent who sometimes helps her kids with their school assignment. He further indicates that a similar interpretation can be given for other agent nominals like **elɔɔfabo** 'healer', **odzibo** 'glutton', **ɔkplabo** 'traditional priest', and **bɔɔbɔpi** 'footballer'. On the other hand, he adds that others like **ɔpenibo** 'pregnant woman', **ɔkodzibo** 'someone who has given birth/mother', **ɔfiabo** 'scrounger/parasite' may refer to people who partake in uncharacteristic activities. For instance, **ɔpenibo** 'pregnant woman' can only refer to someone who is presently

pregnant irrespective of whether or not this is the first time, not someone who habitually gets pregnant. Likewise, **ɔkɔdʒɪbo** is characteristically used to refer to a woman who has presently given birth to a new baby; not someone who is found of given births and probably has about twelve children.

4.3.3.2 Agentive Nominalization through Compounding and Affixation

This process is very productive in Dagbani as far as nominalization and for that matter word formation processes are concerned. It involves the combination of two different lexical items before attaching an affix to the conjoined words to derive nominals. Thus, different nominalizing strategies are employed in this process which is depended on the lexical items that are involved in the process. The Table 15 below illustrates the phenomenon.

Table 15: Verb-Noun Compound-Suffix derive agentive nominals in Dagbani

Verb	Gloss	Noun	Gloss	Nominalized form	Gloss	Ill-formed
a) chaŋ	'go'	solɪ	'road'	sochanda	'traveller'	*Solichanda
b) ba	'ride'	wahu	'horse'	warɪbara	'horse rider'	*wahubara
c) da	'buy'	nahu	'cow'	nayɪdara	'buyer of cow'	*nahudara
d) pali	'collect'	kuliga	'water source'	kulɪpala	'fisher/ fisherman'	*kuligapa
e) yoli	'nurse'	bia	'child'	biyola	'babysitter'	*biayola
f) kɔhi	'sell'	nahu	'cow'	nakoɔha	'butcher'	*nahukoɔha

From the above Table 15, we have seen that the nominals are derived through two processes, thus compounding and affixation with different affixes. For Table (15a),

the suffix [-da] was attached to the compound words whilst in Table (15b & c) and (15d - f) the suffixes [-ra] and [-a] are used respectively. Furthermore, regarding the order in which this phenomenon occurred, it is compounded by reversing the order (to become N-V) before suffixation. This type of compounding is endocentric since the meaning can be found within the words that are compounded. There are some changes in the word combination. For instance, Table (15a, d & f) undergo some form of phonological process, there is deletion of their last syllables of the noun to enable them combine with the verbs. For instance, Table (15a) has to do away with last syllable /-li/ to be able to combine with the word **chaŋ**. Table (15d) too had the last syllable /-ga/ deleted to allow it combine with the word **pali**. Similarly, Table (15f) too had the syllable /-hu/ of the noun elided to be able to combine with the verb **kɔhi** ‘sell’. Whilst in Table (15e), there is deletion of the final vowel /a/ before combining with the word **yoli**. It is worth mentioning that this process of nominalization is very productive in Dagbani.

4.3.3.3 Agentive Nominals through Compounding and Affixation

This is the situation where an agentive nominal is derived from other through compounding and affixation. As discussed above, this area looks at what other compound features are employed in Dagbani to form nouns. This type of agentive nominalization involves conjoining noun and a verb before suffixing an agentive nominalizer **-ra** to derive agentive nominals. Furthermore, regarding the order in which this phenomenon occurred, it is compounded by reversing the order (from V-N to become N-V) before suffixation. Consider the following examples in Table 16 below:

Table 16: Nouns-Verb + Suffix derive agentive nominals in Dagbani

VERB	GLOSS	NOUN	GLOSS	NOMINAL	GLOSS
a) di	'eat'	liyiri	'money'	laydira	'one who spends money'
b) di	'eat'	buni	'wealth/riches'	bundira	'one who spends wealth'
c) ku	'kill'	buni	'wealth'	bunkura	'extravagant person'
d) nyu	'drink'	dam	'alcohol'	danyura	'a drunkard'

It can be observed from Table 16 above that, in Dagbani, one of the agentive suffixes **-ra** that is attached verb stems to form agentive nouns. It can be observed closely that when this combination is done, its meaning does not stand out clearly unless it combines with the root of a noun as in “buni” ‘wealth’ to form a noun. It can also be observed that the above nouns to be combined lose some part, thus, a syllable, a vowel or a final consonant get deleted in the process. For instance, in Table (16a), the final syllable including the final vowel of the noun is elided. In addition, whilst Table (16b & 16c) has their final vowel of the nouns deleted, Table (16d) experienced a final consonant deletion. This analysis confirms the observation of Abdul-Rahaman (2013, p. 8) that when two or more words are compounded in Dagbani, they trigger a vowel, a consonant or a syllable elision. All of the compounds in this category are endocentric.

4.3.3.4 Agentive nominals derived from inherent complement verbs through affixation

Some Dagbani action verbs are compound in nature since they obligatorily co-occur with a meaning specifying nominal element which has been referred to as inherent

complement (Nwachukwu 1985, 1987; Asante, 2018) or obligatory complements (Badan, 2012 cited in Anyanwu & Omega, 2015, p.6). In Dagbani the inherent complements can exhibit two phenomena; these include those that are cognates with their respective inherent complement verbs and in some cases both the inherent complement and its verb are morphologically different. This class of verbs is generally referred to as inherent complement verbs and their meaning is fully realizable only in the context of the obligatorily accompanying inherent complements. Thus, it is expected that in the lexicon of Dagbani and some other languages with these phenomena, the inherent complements and their associated inherent complements constitute one lexeme. Dagbani deverbal agentive derived from such verbal compounds, are obligatorily accompanied by a noun complement and a suffix which denotes the activity carried out by the agentive noun. Examples are shown in (Table 17), the inherent complements are indicated in bold italics.

Table 17: Agentive nominals derived from (ICVs) through affixation

Verb - Noun	Gloss	Derived Agentive	Gloss
a) wa <i>waa</i>	‘dance (a dance)’	wa <i>wara</i>	‘dancer’
b) yili <i>yilli</i>	‘sing (a song)’	yili <i>yiina</i>	‘singer’
c) zahim <i>zahinli</i>	‘dream (a dream)’	zahim <i>zahinda</i>	‘dreamer’
d) zabi <i>zabili</i>	‘fight (a fight)’	zabi <i>zabira</i>	‘fighter’
e) yo <i>yɔri</i>	‘pay (a salary)’	yo <i>yɔra</i>	‘payer/cashier’
f) salim <i>salinli</i>	‘tell (a story)’	salim <i>salinda</i>	‘story teller’
g) moli <i>molo</i>	‘announce (announcement)’	moli <i>moona/moonda</i>	‘announcer’

As it is observable in Table 17 above, the agentive nominals are derived with inherent complement verbs with their cognates. This phenomenon is equally observed in (Igbo language, (Nwachukwu, 1985, 1987).

Since an inherent complement and its inherent complement verb constitute a lexical unit, its derived deverbal agentive counterpart also constitutes a lexical unit. Thus, such an agentive is not byproducts of syntactic nominalization but lexically motivated deverbal nominalizations. Similarly, if the deverbal agentive is derived from inherent complement verbs without their inherent complements, such derivations will be unacceptable. Thus, agentive derivations such as those in (13) will not be well-formed in Dagbani.

- | | | |
|-----|-------------------------|-----------------|
| 13. | a) <i>*wara</i> | ‘dancer’ |
| | b) <i>*yiina</i> | ‘singer’ |
| | c) <i>*zahinda</i> | ‘dreamer’ |
| | d) <i>*zabira</i> | ‘fighter’ |
| | e) <i>*yɔra</i> | ‘payer/cashier’ |
| | f) <i>*salinda</i> | ‘story teller’ |
| | g) <i>*moona/moonda</i> | ‘announcer’ |



Furthermore, it is also revealed in the study that agentive nominalization can be derived from inherent complements with their verbs morphologically different through affixation. This process similarly is observed in Tee language (Anyanwu & Omega, 2015).

Table 18: Derived agentive nominals from (ICVs) through affixation

Verb – Noun	Gloss	Derived Agentive	Gloss
a) di <i>sa?im</i>	‘eat TZ’	sa? <i>dira</i>	‘TZ eater’
b) da <i>nimdi</i>	‘buy meat’	nin <i>dara</i>	‘meat buyer’
c) ba <i>cheche</i>	‘ride bicycle’	cheche <i>bara</i>	‘bicycle rider’
d) ba <i>wahu</i>	‘ride horse’	war <i>bara</i>	‘horse rider’
e) nyu <i>dam</i>	‘drink alcohol’	danyu <i>ra</i>	‘drinker/drunkard’

As it is realized in Table 18 above, in deriving such agentive nominals, there is a reversal/re-ordering of the inherent complement verbs with their objects. It is observed that final segment deletion of some the nouns (objects) are deleted in the reversal process. For instance, in table (18b & 18d) experienced final syllable elision whilst the final vowels in table (18a & 18e) are deleted. It is equally important to know that when the last syllable in table (18d) was deleted, the syllable /ri/ was attached to the noun in reversing the order. This observation is common in Dagbani especially in words that end with the syllable /hu/ in words like **nahu** ‘cow’ and **wahu** ‘horse’.

Equally, such derivations in Table (18a - 18e) will be unacceptable if the deverbal agentive are derived from inherent complement verbs without their inherent complements. Thus, agentive derivations such as those in (14) will not be well-formed in Dagbani.

- (14) a) **dira* ‘eater’
 b) **dara* ‘buyer’
 c) **bara* ‘rider’

- d) **bara* 'rider'
 e) **nyura* 'drinker/drunkard'

4.3.3.4 Syntactic Functions of the Agentive Nominals

Regarding the distributional properties of agent nominalizations in Dagbani, they can function as subject, object arguments or as possessed as examples (15), (16) and (17) illustrate respectively.

4.3.3.4.1 Subject Position

- (15) (i) **karimbihi maa di bindirigu maa yomyom**
 student-PL DET eat food DET fast-RED

'The students ate the food fast'

- (ii) **sochandiba maa daa chani-la yuŋ**
 traveler-PL DET TD go-PST night

'The travelers used to walk in the night'.

(The travelers were walking in the night)

- (iii) **daabihi maa bi kana daa zuŋɔ**
 Trader-PL DET NEG come market today

'The traders did not come to market today.'

4.3.3.4.2 Object position

- (16) (i) **gomnanti ti la pukpariba layipaŋda**
 Government give-PST FOC farmer-PL loan

'The government gave loans to farmers'

- (ii) **gomnanti daa bi kpuyi tuuntumdiba yuma din gari la**
 Government TD NEG take-PERF worker-PL year-PL REL past DET

'The government did not recruit workers in the past years'.

4.3.3.4.3 AG.N as possessum

- (17) (a). **n** **karimba** **sabiri** **yomyom**
 1SG.POSS teacher-SG write-IMPERF fast-RED
 ‘My teacher writes fast.’
- (b). **Aminu** **tuuntumdiba** **maa piligi tuma tumbu.**
 worker-PL worker-PL DET start work working
 ‘Aminu’s workers have started the work’

In the above examples (15 & 16) it shows that agentive nouns can function as a subject, an object as well as the possessed noun in the possessive phrase as observed in example (17). It also reveals in the data that an agent noun can take determiners and modifiers including numerals, quantifiers and descriptive adjectives within the Dagbani sentence structure as seen in the examples above.

4.4 Patient Nominalization

This refers to a nominalization of the patient of the nominalized verb. Asante (2018, p. 18) says that patient nominalization refers to an operation that derives a nominal that refers to a patient of a verb. Patient nominals are derived in Dagbani through morphological strategies. Patient nominals are derived in Dagbani by using two morphological processes, compounding and affixation, simultaneously. Let’s consider the following processes/strategies.

4.4.1 Patient nominalization through compounding and affixation

Dagbani realizes patient nominals through the suffix -li. See Table 19 for some examples of patient nominals based on simple verb stems and nouns.

Table 19: Noun-Verb-suffix Compound Patient Nominals

Noun	Gloss	Verb stem	Gloss	Suff	Nominalized Item	Gloss
a) wahu	horse-SG	bari	‘ride’	-li	waribarili	‘a horse used for riding’
b) nyuli	‘yam’	dari	‘buy’	-li	nyu darili	a bought/buying yam’
c) nimdi	‘meat’	sheri	‘roast’	-li	nimsherili	‘roasted/roasting meat’
d) shinkaafa	‘rice’	kohiri	‘sell’	-li	shinkaafa/shinkaakohirili	‘sold/selling rice’
e) sayim	tuo zaafi	duyiri	‘cook’	-li	sayi duyirili	‘cooked/cooking TZ’

From the above examples in Table 19, we can see that the process of patient nominalization exhibits compounding of a noun and imperfective verbs and a suffix nominalizer [-li] that denote patient nominals. It must be noted that the last syllables of the nouns get deleted when compounded to the verbs as exemplified in Table (19a - d). Also, in Table (19e), the last consonant of the noun is deleted. This observation confirms the assertion of Abdul-Rahaman (2013) that when two words are compounded in Dagbani, the last segment either a vowel, consonant or a syllable is deleted before the preceding word is compounded.

At the level of syntax, the patient nominals may function as subject and object arguments of clauses. Let’s consider the following sentences in (18):

4.4.2 Subject position

(18) (i). **waribarili maa bi chaŋ moyuni zuŋɔ**
 horse riding DET NEG go bush today

‘The riding-horse did not go grazing today.’

(The horse used for riding did not go grazing today)

(ii). **Nimsherili maa naaya**
 roasted meat DET finish-PERF

‘The roasted meat has finished’

4.4.3 Object position

(19) (i). **Tijonaa da la waribarili**
 Tijonaa buy FOC riding horse

‘Tijonaa (has) bought a horse’

(ii). **Balima kɔhiri la nyusherili**
 Balima sell FOC yam roasting

‘Balima sells roasted yams’

4.5 Location Nominalization in Dagbani

As the name suggests, the nominalized form denotes location where the action takes occurs. In Dagbani, the only method or process used to achieve this type locative nominalization is morphological. There is only one suffix identified in the data as a locative nominalizer as exemplified in Table 21 below.

Table 20: Verb-Suffix derive Location Nominals in Dagbani

Verb stem	Gloss	Nominalized item	Gloss
a) doo	‘lie’	dooshee	‘a place for sleeping’
b) gom	‘sleep’	gomshee	‘a place for sleeping’
c) dibu	‘eating’	dibushee	‘a place to eat’
d) sahibu	‘sharpening’	sahibushee	‘place where things are sharpened’
e) jema/jembu	‘worship’	jema/ jembushee	‘a place where people pray’ (a place of worship)
f) malibu	‘making’	malibushee	‘place where things are made/repared’
g) duyili/ duyibu	‘cooking’	duyibushee	‘place where food is cooked’
h) shebu	‘sew’	shebushee	‘place where things are sewn’
i) vuhim	‘resting’	vuhimshee	‘place for resting’

As has been illustrated from the Table 20, there is only one locative nominalizer identified in the data. As noticed, different verb roots are used to attach to the suffix to form a locative nominal. The locative nominalizer (**-shee**) cannot be used in isolation.

It is rather suffixed to the verb base or stem to form a locative nominal in the language.

4.6 Experiencer Nominalization in Dagbani

An experiencer is the “subject of a copular verb of a transitive verb of perception, cognition or emotion” (Thakur, 2010, p.68). In the light of this definition by Thakur, experiencer nominalization is the process where a nominalized form expresses either emotion or perception that the verb denotes. In Dagbani, experiencer nominalization is achieved through affixation, thus, attaching some suffixes to verb stems. Consider Table 21 below;

Table 21: Verb-Suffix derive experiencer nominals in Dagbani

Verb	Gloss	Nominalized form	Gloss
a) wum	‘listen’	wumda	‘listener’
b) bəhim	‘learn’	bəhinda	‘learner’
c) lihi	‘view’	lihira	‘viewer’
d) baŋ	‘know’	baŋda	‘acknowledgeable/experienced person’

From the examples in Table 21, it is observed that two different nominalizers are employed to derive the nouns. These examples are not exhaustive. It can also be recalled that these nominalizers are also employed in the formation of agentive nominalization including patient nominalization in Dagbani. It is noted even though the nominalizers mark those types of nominalization; the verbs used in these contexts

means differently. This observation confirms a similar assertion made by Djaki (2001, p.23) that a single nominalizer can be used to derive more than one type of nominalization in Bete, a Bantu language spoken in Cote D’Ivoire. In table 21(b) has shown assimilation process where it assimilates the place of articulation of the following consonant. For example, the last bilabial nasal /m/ consonant assimilates to an alveolar nasal /n/ in the environment of a voiced alveolar stop /d/. The sentences in example (20) below denote some functions of the experiencer nominalization in Dagbani:

4.6.1 Experiencer Nominals functions as object

(20) (a).	N	ni	zani	kpe	ka	puhi	a	wumdiba
	1SG	FUT	stand	here	CONJ	greet	2SG.POSS	listener-PL
	‘I will end here by sending greetings to your listeners’							
(b).	N	ni	puhi	ban	kam	nye	a	lihiriba
	1SG	FUT	greet	REL	ever	COP	3SGPOSS	viewer-PL
	‘I will greet those who are your viewers.’							

From the illustration in (20), it can be observed that the derived nominals **wumdiba** ‘listeners’ and **lihiriba** ‘viewers’ both function as possessed nominals within the syntactic slots.

4.7 Instrumental Nominalization

Another type of participant nominalization is the instrumental nominalization. Instrument nominals have the denotation of the ‘thing’ used to perform the action of the verbal idea. Following (Payne, 1997, p.228), instrument nominalization refers to “a noun formed from a verb in which the noun refers to an instrument used to accomplish the act represented by the verb.” We can simply say that instrument

nominals refer to the tool or equipment for the action. As far as this study is concerned, the only method that is exhibited in this type of nominalization in Dagbani is a morphological strategy. Instrumental nominalization is achieved by deriving nouns from the action verbs through affixation.

4.7.1 Instrumental Nominalization through Affixation in Dagbani

The instrument nominalization operators include suffixes such as **-ga** and **-gu/-gɔ** suffixed to the verb stem or base to derive nouns. We can exemplify the process in Table 22:

Table 22: Verb-Suffix derive Instrument Nominals in Dagbani

Verb base	Gloss	Nominal	Gloss
a) sheri	‘sew’	sheriga	‘needle’
b) yeri	‘pluck’	yeriga	‘tool used to pluck roots’
c) sahi	‘sharpen’	sahigo	‘tool used to sharpen things’
d) teri	‘to sieve’	terigo	‘tool used to sieve/sieve’
e) diri	‘eat’	dirigu	‘spoon/something used for eating’

As we can see in Table 22 above, the resulting nouns refer to instruments used to accomplish the acts represented by the verbs. What conditions the choice of **-ga** or **-gɔ** is to follow the rule of vowel feature harmony. The data for this analysis on the subject is not exhaustive.

4.8 Result/ Product Nominalization

This is a type of nominalization shows or gives the result or product of an activity being performed a performed act. This phenomenon is highly productive in Dagbani. Result or product nominalization is morphologically achieved by attaching variety of suffixes to verb stems to derive nominals in Dagbani. Consider the following examples in Tables (23) and (24).

Table 23: Verb-Suffix derive Product Nominals in Dagbani

Verb stem	Gloss	Nominal	Gloss
a) zali	‘to make a law’	zaliɔ	‘law’
b) kperi	‘play’	kperigu	‘a play/ drama’
c) mali	‘perform’	maligu	‘performance’
d) lihi	‘look’	lihigu	‘a look’
e) bɔhi	‘ask’	bɔhigu	‘question’
f) boli	‘call’	boligu	‘a call’
g) yeli	‘say’	yeligu	‘saying/speech’
h) kuhi	‘cry’	kuhigu	‘a cry’
i) layim	‘group/assemble’	layiŋgu	‘congregation/assembly’

From the Table 23, it is realised that the product nominals are formed by the combination of combination of a base and a suffix nominalizer. It must be established that table (23i) showed evidence of homorganic assimilation. The bilabial nasal /m/ assimilates to the place of articulation of a velar plosive /g/ by changing the bilabial nasal to a velar nasal /ŋ/.

Apart from the above suffixes mentioned, it is possible to derive product nominals from other suffixes and means. Consider the following examples in Table 24.

Table 24: Verb-Suffix derive Product Nominals in Dagbani

Verb	Gloss	Nominalized form	Gloss
a) sabi	‘write’	sab <u>bu</u>	‘writing’
b) yili	‘sing’	y <u>illi</u>	‘song’
c) wa	‘dance’	w <u>aa</u>	‘dance’
d) tehi	‘think’	t <u>eha</u>	‘thought’
e) pili	‘to begin/start’	p <u>illi</u>	‘beginning’

It can be realized in Table 24 above that the process of forming object or result nominalization assumed a different dimension. For instance, in Table (24a), the suffix **-bu** is attached to the verb root to derive the result nominal. Also, in Table (24b & e), the product nominals are formed by attaching the product nominalizer **-li** to the stem of the verbs. This process also triggers final vowel elision of the verb stem. Therefore, the **CV.CV** structure of Table (24a, b & e), has changed to **CVC.CV** structure. However, as seen in the case of Table (24c & d), the verbs are suffixed with **-a** to form the product nominals. It can further be observed that in Table (24c), the suffix is attached to lengthen the verb whilst in (d), the suffix triggered a final vowel elision before nominalizing the verb stem.

As we can see in Table 23 above, the suffix **-gu** is attached to disyllabic verb roots. It is important to note that when the suffix is attached to the verb stems the final vowel changes to /i/ or the schwa (ə) as claimed by Olawsky (1999) and Hudu (2010) respectively. This observation is in sharp contrast to Adam (2006) which makes the claims that when the suffix is attached to some verb stems, the last vowel is deleted completely after the liquids. Consider the following examples in Table 25.

Table 25: Verb-Suffix derived Product nominals in Dagbani

Verb	Gloss	Nominalized form	Gloss
a) yuli	‘look’	yuligu	‘a look’
b) mali	‘perform’	maligu	‘performance’
c) gbeli	‘stare’	gbeligu	‘a stare’
d) boli	‘call’	boligu	‘a call’

Observing from table 25 above, I argue that what is seemed to have occurred is that the vowel in the second syllable of the verb stem CVCV, the vowel in the second syllable is weakened to assume the features of a mute vowel /i/ being epenthesis (cf Huđu, 2010 and Olawsky, 1999).

The data below in examples in Tables (26 & 27) show how different nominal suffixes are attached to noun stems to form nominals.

Table 26: Verb-Suffix derived Product nominals in Dagbani

Noun	Gloss	Nominalizer	Nominal	Gloss
a) nira	‘person’	-lim	nirilim	‘kindness’
b) yura	‘lover/ love’	-lim	yurilim	‘love’
c) bia	‘child’	-lim	bilim	‘childishness’
d) bidibiga	‘boy’	-lim	bidibilim	‘boyish exuberance’

As can be seen from the data above, Table (26a - c) have to do away with their last vowel to enable them attract the suffix **lim** whilst (d) has the last syllable elided. It is noticed that Table (26a - d) have the schwa inserted when the last vowel or syllables is elided to break consonant cluster (CC). Also, in Table 27, the suffix nominalizer **tali** is attached to nouns to derive other nouns in the language.

Table 27: Noun-Suffix derive Result/ Product Nominals in Dagbani

Noun	Gloss	Nominalizer	Nominalized items	Gloss
a) ninsala	‘humanbeing’	-tali	ninsalitali	‘humanity’
b) doo	‘man’	-tali	dotali	‘manhood’
c) paya	‘woman’	-tali	payitali	‘womanhood’
d) jerigu	‘fool’	-tali	jeritali	‘foolishness’

Judging from the data above, nouns that have disyllabic structure have to drop a segment either the last vowel, consonant or a full syllable. Except for Table (27d) which last syllable has been dropped before the attraction of the suffix (-tali). In Table (27a - c), the last vowel was dropped to attract an insertion of a mute (i) to create an enabling environment for the suffix. In addition to this observation, Table (27b) has its long vowel shortened before it is nominalized. The derived nominals denote result nominalization.

4.8.1 Syntactic functions of the result nominalization

The result nominalization may also exhibit some syntactic functions within the sentence structure of Dagbani. Let's consider the illustrative sentences under review in 21;

(21)(a). **Bene sabbu viɛla**

Bene handwriting be-good

‘Bene’s handwriting is good’

(b). **Binnamda naa zali zaligu**

Creator king pass law

‘God has passed a law’ (Kaleem, 1955 cited in Gurundoo, 2014, p.13)

- (c). **Dagbani yelli kam doli la vihigu**
 Dagbana matter every follow FOC investigation
 ‘Everything of a Dagbana is done based on investigation’
 (Andani, 1968, p.7 in Gurundoo, 2014, p.57)

The examples showed above, explain how the object nominals can be represented syntactically. In example (21a), the object nominal functions as possessed with the possessor being the noun ‘**Bene**’. Both example (21b & c) functions as objects in the sentences.

4.9 Manner Nominalization

Manner Nominalization means the way an action is done. In Dagbani manner nominalization is realized by attaching the manner nominalizing suffixes; /ri/, /bu/, /di/ or /li/ to verb stems or roots to derive a manner nominal. This phenomenon is illustrated in table 28 below;

Table 28: Verb-Suffix derive Manner Nominals in Dagbani

Verb	Gloss	Suff	Nominalized form	Gloss
a) la	‘laugh’	-ri	lari	‘laughter’
b) chaŋ	‘walk/go’	-di	chandi	‘way of walking’
c) duyɪ	‘cook’	-li	duyili	‘way of cooking’
d) za	‘stand’	-a	zaa	‘way of standing’
e) di	‘eat’	-bu	dibu	‘way of eating’

The examples above indicate different nominal markers used to derive the nouns. The verb roots comprised the CV, CVC, and CVCV syllable forms. Except for Table (28b) undergoing homorganic nasal assimilation, the rest of the examples in the table have remained unchanged.

Moreover, manner nominalization may also be used syntactically to show the manner in which an action is done. Let's consider the following sentences under review;

- (22) (i) **Wuntiti loori duhibu sayindi suhu**
 Wuntiti lorry driving break heart
 'Wuntiti's way of driving breaks heart'
- (ii) **Sirina yila yilibu maari suhu**
 Sirina song-PL singing cool-IMPERF heart
 'Sirina's way of singing touches heart.' (She sings well)
- (iii) **pəhim ŋɔ ʒɛbu wuhiri la sanzali**
 air DEM blowing-NOM show FOC drought
 'The blowing of this wind shows drought.'

4.10 Autosegmental Phonology Representation of nominalization in Dagbani

As we have already discussed Autosegmental phonology in chapter two. The essence of this section is to provide Autosegmental Phonology representation of the phonological processes identified in the data. The most common phonological processes that take place in the formation of these nouns are assimilatory and syllable structure processing. These analyses are done using Autosegmental Phonology (Goldsmith, 1976) because of its superb representation capacity and its provision of independence to all segmental features.

4.10.1 Assimilation

The data revealed that some derived nouns undergo assimilation in its formation. Assimilation is a phonological process in which a sound is made to take the features of the adjacent sound. According to Otoo (2005), assimilation process is seen as

“sounds in a sequence where one sound acquires a feature of a neighbouring sound so that both sounds assume the same features.” Assimilation can be realized at place of articulation and vowel harmony. The type of assimilation that occurs when a sound of different place of articulation takes the same place of articulation of the adjacent sound is the place of articulation.

In nominalization, the derived nominals also undergo the process of assimilation where a segment is made to look like the adjacent sound. The most common type of assimilation that occurs in Dagbani derived nominals are vowel harmony and homorganic nasal assimilation.

4.10.1.1 Autosegmental Account of Homorganic Nasal Assimilation (H.N.A)

Example 23

a. **sayim -gu** → **[sayiŋgu]**
 destruct suffix ‘destruction’



Underlying form:

P.A Tier

[bilabial]

[Velar]

Skeletal Tier

x

x

x

x

x

x

x

Segment tier

s

a

y

i

m

g

u



Velar feature leftward Spreading:

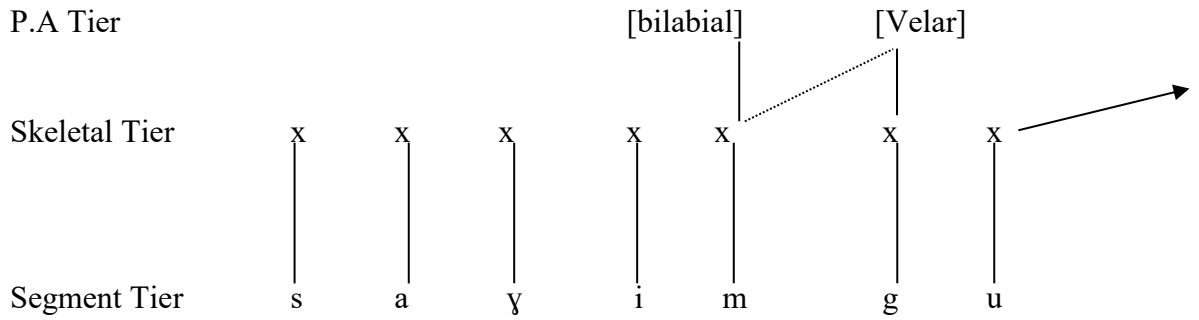

Bilabial feature delinking:

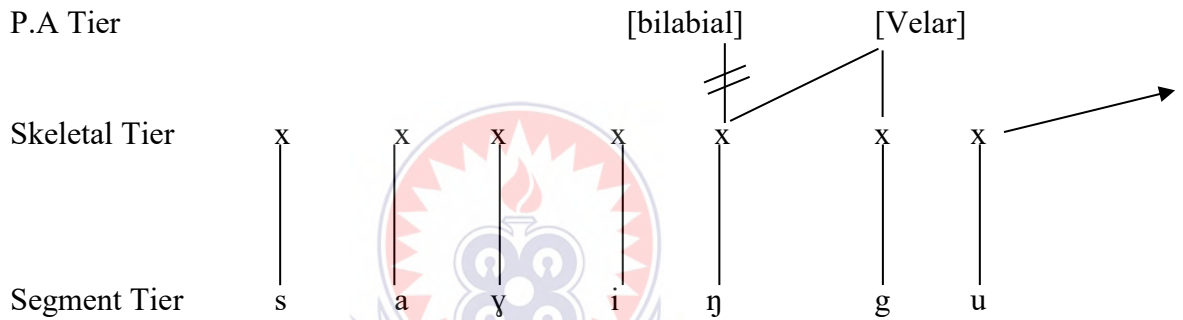

Output form:

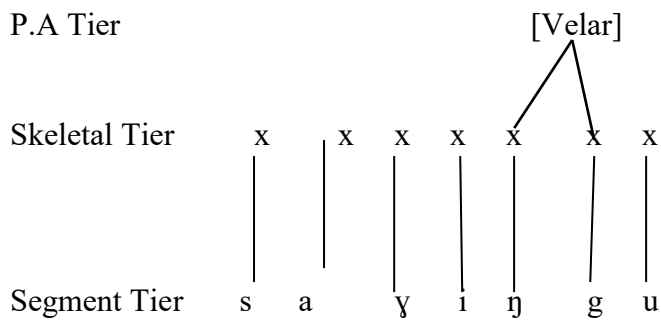

b. kariŋ + ba → [karimba]
 'studies' 'father'

Underline form:

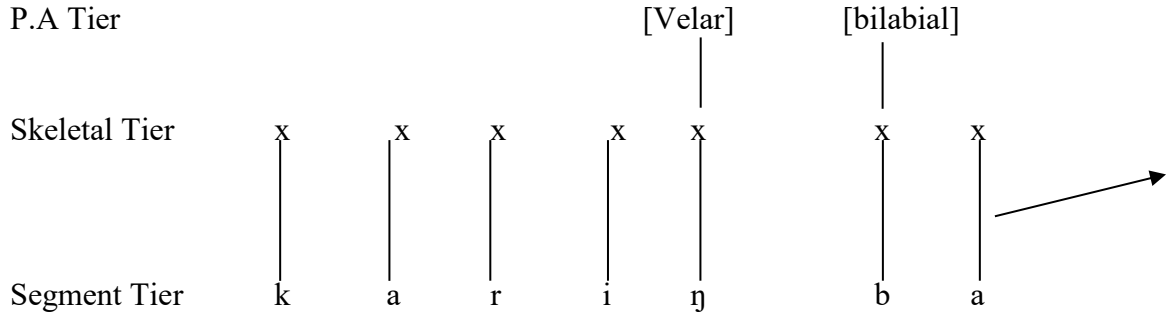

Bilabial feature leftward Spreading:

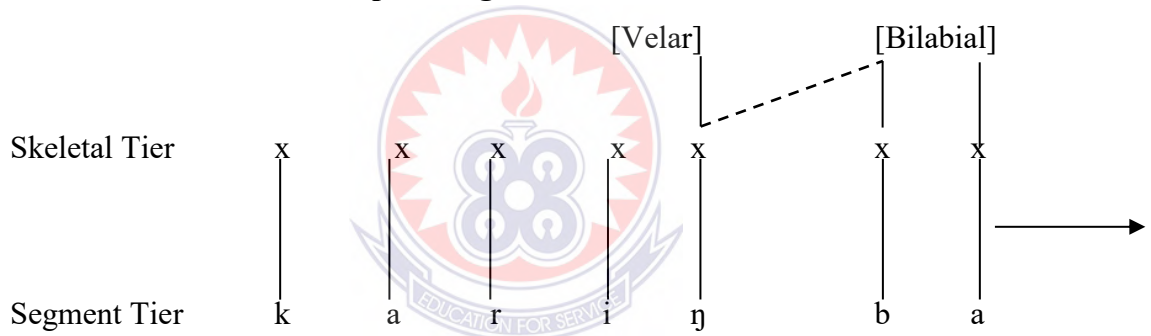

Velar feature delinking:

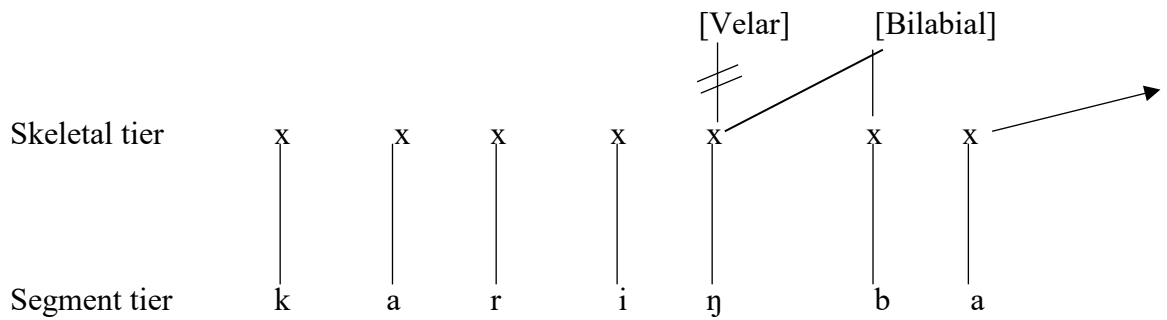

Output form:

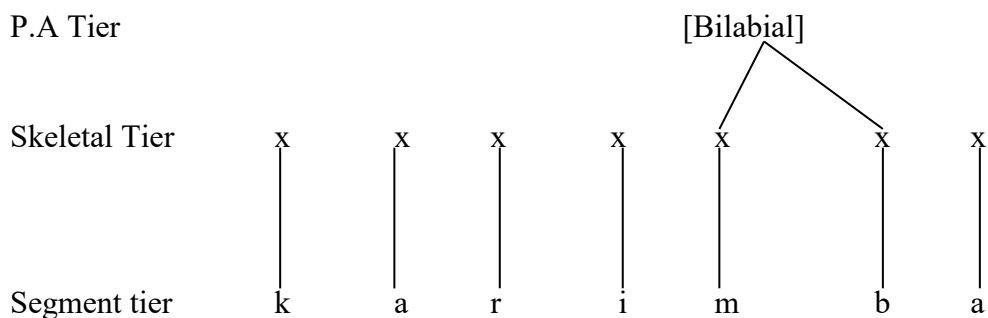

c. **zahir** + **da** → **[zahinda]**
 'dream' suffix-NOM 'dreamer'

Underlying form

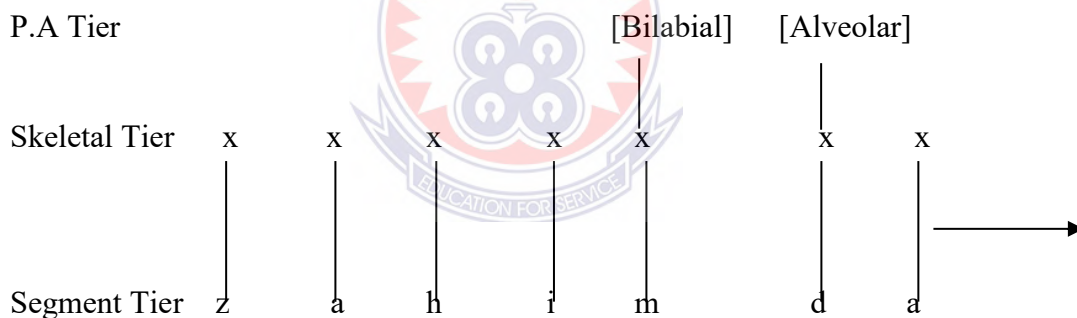

Alveolar feature leftward Spreading:

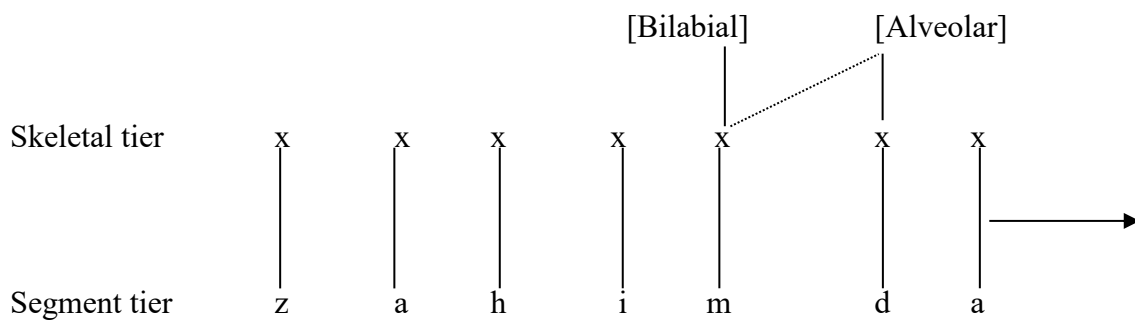

Bilabial feature delivering:

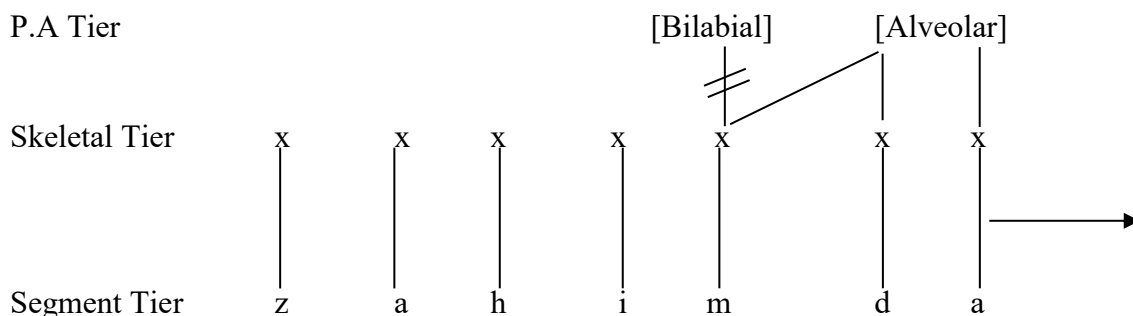

Output form:

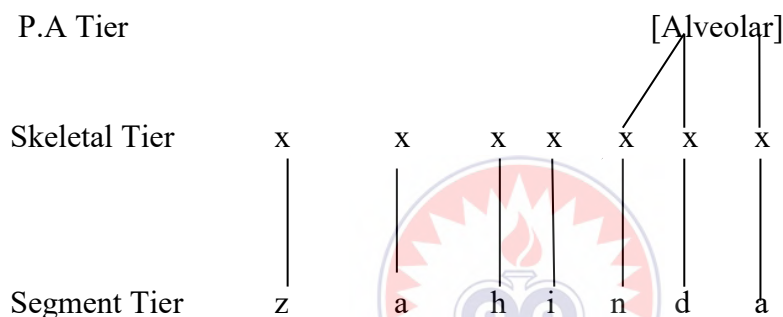

Example (23a) shows velar-plosive assimilate bilabial nasal /m/ between the boundaries of the word and suffix nominalizer during nominalization to be a velar nasal /ŋ/ for them to be at the same place of articulation. Example (23b) also shows a similar homorganic assimilation process when during the derivation of the compound nominals **kariŋ** and **ba** when the bilabial-plosive /b/ regressively assimilates the velar-nasal /ŋ/ ending the first word to become a bilabial-nasal /m/. Also, in example (23c), voiced alveolar stop regressively assimilates bilabial nasal between word boundaries to be an alveolar-nasal /n/ for them to be at the same place of articulation. These findings are in line with Abdul-Rahaman (2013).

4.10.1.2 Autosegmental Account of Vowel Harmony Assimilation

As stated earlier in the previous chapter, vowel harmony as a phonological phenomenon exists in Dagbani like many other Gur and Kwa group languages in Ghana. In vowel harmony the harmonic domain shares the same value of some vowel feature known in the literature as “harmonic feature” (Atipoka & Nsoh, 2018, p.106). In this case the section discussed Advanced Tongue Root (ATR) harmony. The ATR feature usually exhibits two properties; the [+ATR] and [-ATR] features. This present study revealed that in nominalization, it is usually the [+ATR] vowels that assimilate [-ATR] vowels to harmonize with them. In summary, the [-ATR] vowels are usually, the targets whilst the [+ATR] vowels are the triggers. (cf Akanlig-Pare & Asante, 2016; Musah, 2010; Hudu, 2010).

Example 24

a. **zali -gu**

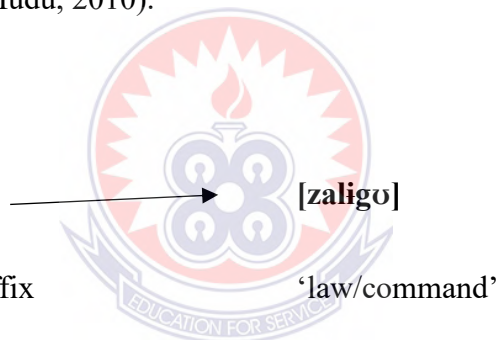

Underlying form:

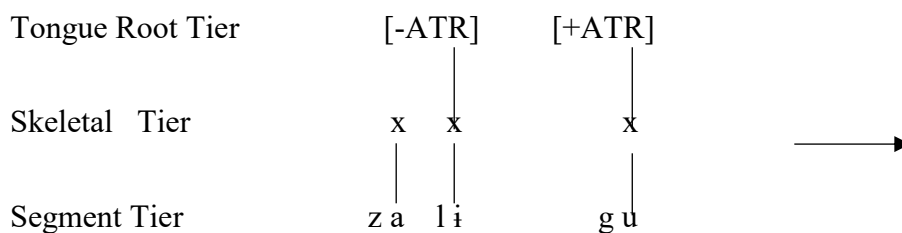

[+ATR] right - ward spreading:

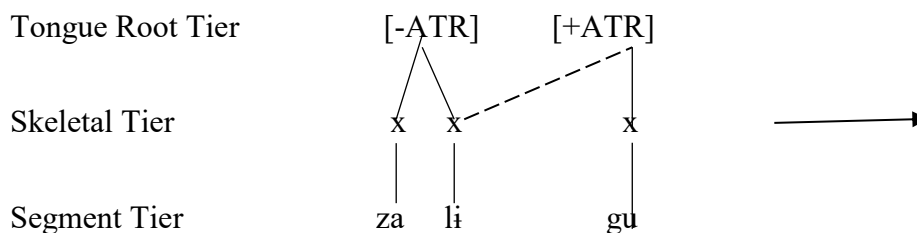

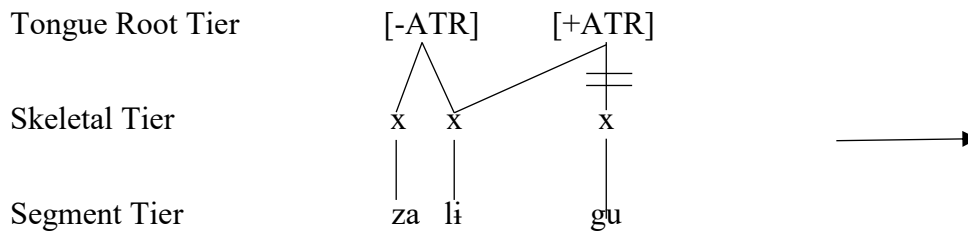
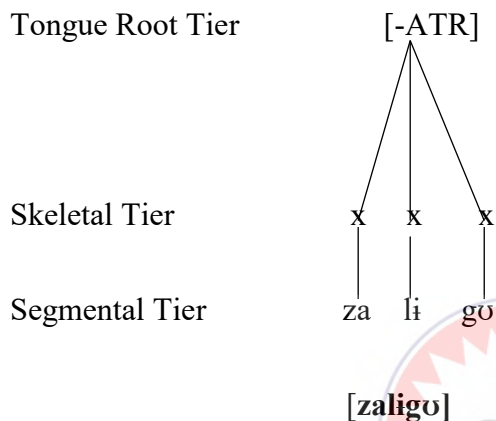
[+ATR] Delinking:**Output:**

In example (24a) the [+ATR] vowel /u/ is changed to /o/ under the influence of [-ATR] vowel /o/ to ensure ATR harmony. This observation implies that a [-ATR] vowel can also change to a [+ATR] vowel under the influence of a [+ATR] vowel to a balance ATR harmony in nominalization.

4.10.2 Syllable structure processing

In deriving nominals in Dagbani, the data revealed the most two common syllable structure processes; elision and epenthesis. The syllable structure processes analyzed under this section are elision and epenthesis.

4.10.2.1 Elision

Elision, in nominalization in Dagbani takes the forms. In the data, it is realized that a vowel can be elided in two instances during word compounding or affixation. In the first instance, a final vowel of a word is deleted before the suffix nominalizer is

attached to it to derive the noun. In another development a consonant or a whole is elided. Example 25 attests to the above explanation.

4.10.2.1.1 Autosegmental Account of vowel elision /i/

After we have looked at vowel elision and the environment that trigger it, we are now going to look at vowel elision theoretically with Autosegmental phonology as the tool for discussion in this subsection.

Vowel elision

Example 25

a. **neei + sim** → **[neesim]**
 clear suffix 'clarity'

Underline form:

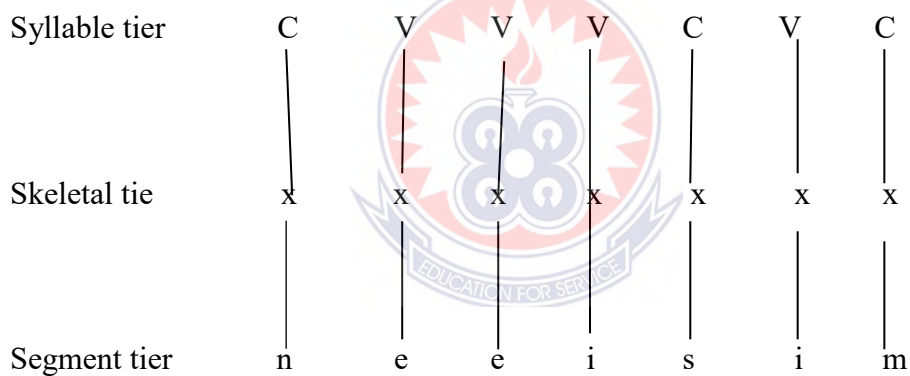

Consonant spreading leftward:

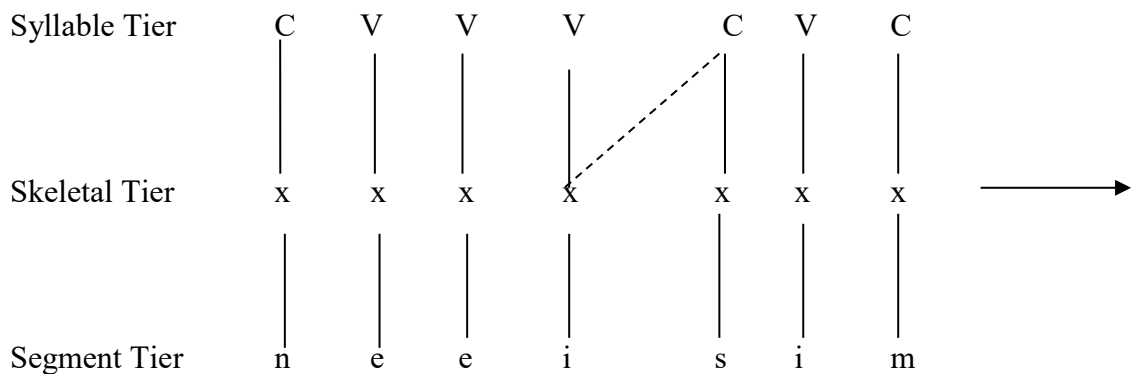

Final vowel delinking:

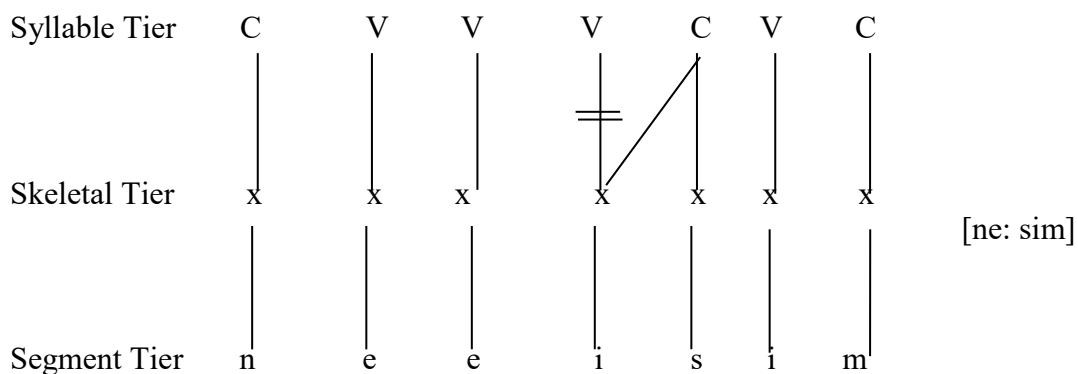

Output:

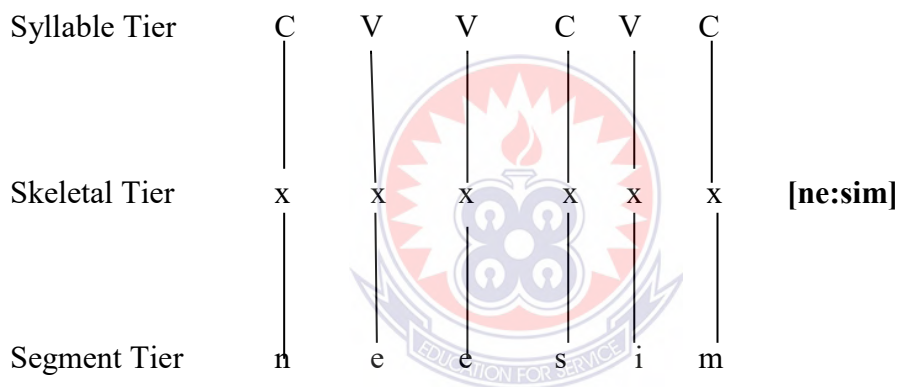

4.10.2.1.2 Autosegmental Account of syllable elision /li/ and vowel lengthening

Example 25

(b) **yoli** + **na** → **[yo:na]**
 'look after something' suffix 'guardian/provider'

Underlying form:

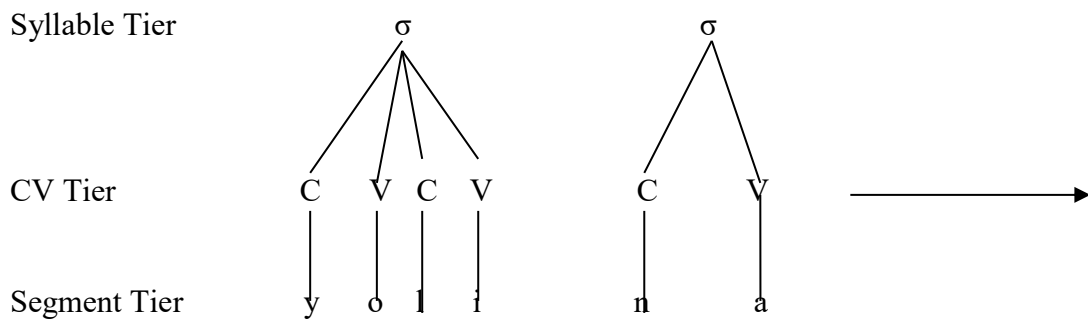

Deletion of a syllable and vowel lengthened:

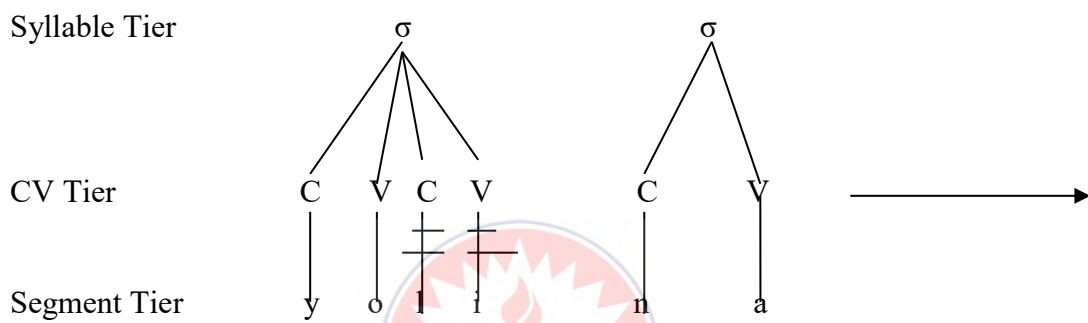

Output

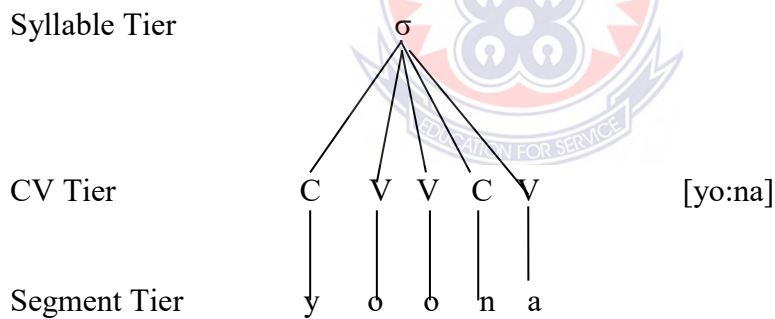

4.10.2.1.3 Autosegmental Account of consonant elision

Example 25

c. dam nyura → **[danyura]**
 'alcohol' 'drinker' → 'drunkard'

Underlying form:

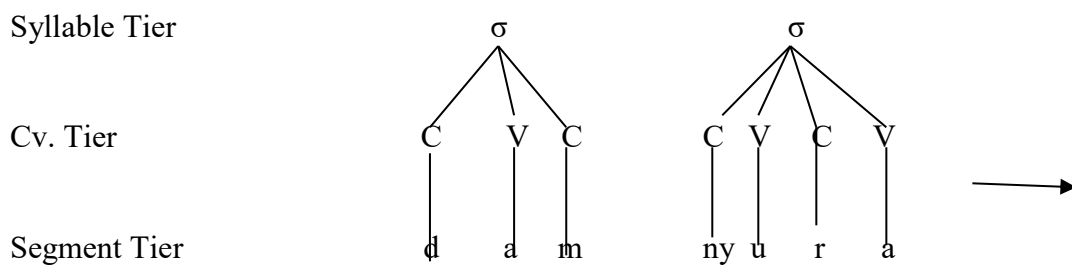

Last bilabial nasal delinking:

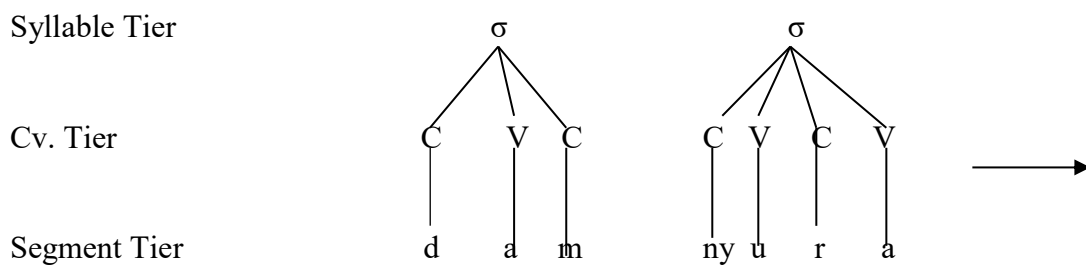

Last bilabial nasal deleting:

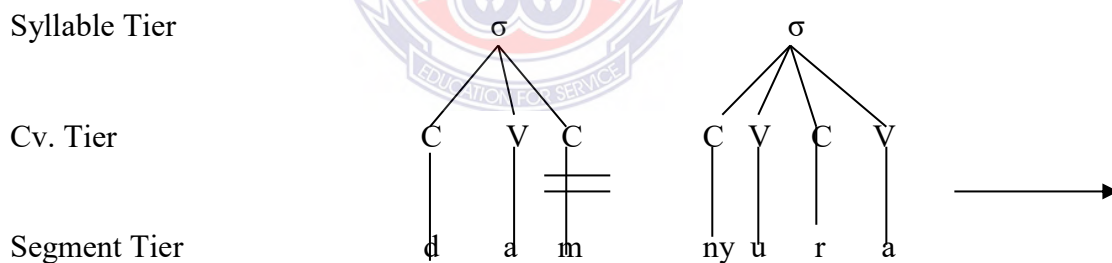

Output:

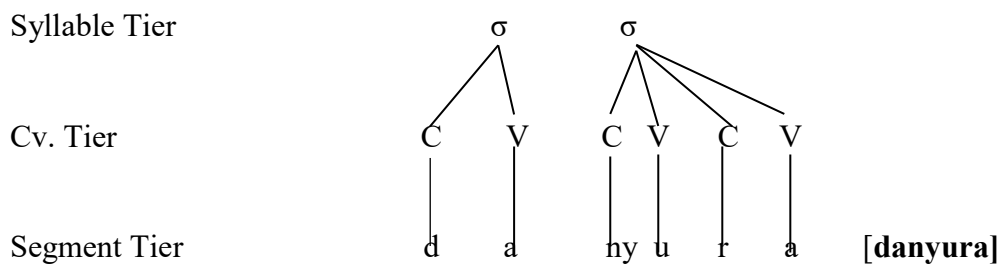

Example 25 shows evidence of elision in nominalization. Example (25a) involves elision of the vowel /i/ in the nominalized forms. In example (25b), the consonant /li/ is deleted which then caused a vowel in the stem to be lengthened before the nominalizer is attached. Finally, in example (25c), in compounding two nouns; a noun and another nominalized agent, the final consonant of the first noun get deleted before the second noun is conjoined to derive another agentive nominal. Generally, elision is a common phenomenon in Dagbani.

4.10.2.2 Epenthesis

Epenthesis is generally seen as one of the strategies employed in the study of syllables that ensure that the syllables in a language are well-formed. In the present study of nominalization, some word formation processes undergo a phonological process of epenthesis. In the study what seemed to undergo epenthesis is the vowel /i/.

4.10.2.2.1 Autosegmental Account of Vowel epenthesis /i/ or /ə/

As we have already discussed vowel epenthesis in chapter two, example below is a theoretical representation of the process discussed.

Example 26

(a). sabi	+	bu	—————▶	[sabbu]
‘write’		NOM		‘writing/handwriting’

Underlying form:

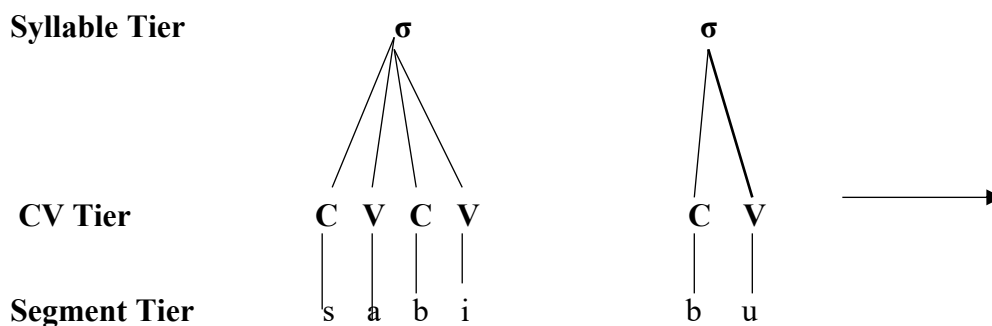

Final vowel deletion and insertion of /ə/ or /i/:

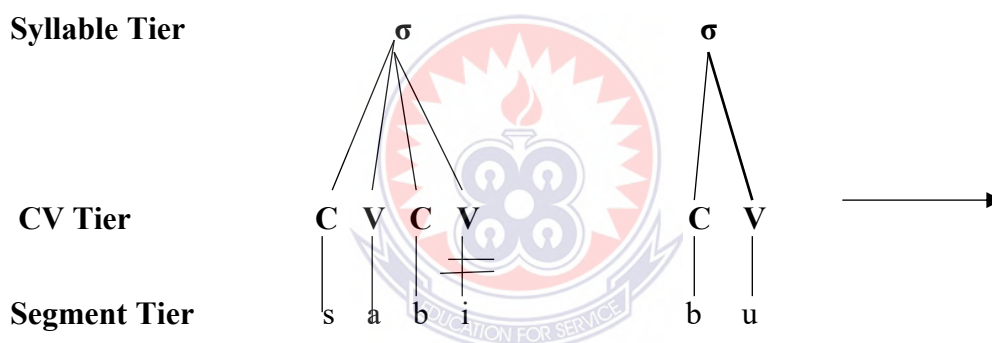

Output:

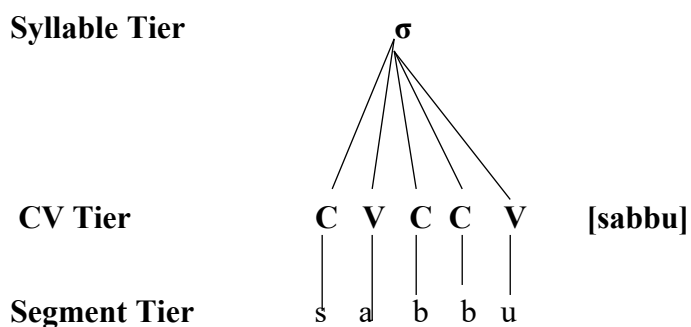

Example 26 above revealed a form of epenthesis found in the study. For instance, (26a) showed vowel epenthesis, where the /i/ was inserted at the boundary between a verb stem and a nominalizer to form a noun.

4.11 Chapter Conclusion

Some efforts have been made in this thesis to provide a comprehensive analysis of some nominalization processes in Dagbani, a Gur language of Ghana. We discussed the types of nominalizations, the strategies for forming them, and some linguistic properties, including semantics, morphology and syntax, of the derived nominals. In the light of the study, it was shown that nouns, but not only verbs, can serve as the base concept for nominalizations in Dagbani. Dagbani shows evidence of the major types of nominalizations, action, stative, agent, location, manner and patient nominalization. The study revealed that all these types of nominalization are derived through the processes of suffixation, reduplication and compounding through a morphological strategy. The study again, revealed that generally, all the types of the derived nominals in Dagbani may exhibit most or all the syntactic properties of prototypical nouns; that is to say that, they may take nominal suffixes, take modifiers including descriptive adjectives, quantifiers and determiners, they may also function as possessed NPs in simple possessive constructions and may equally be focused in focused clause constructions. Finally, in relation to Agent nominalization, the study revealed that, the suffixes **-da** and **-ra** are also used for Patient and Experiencer nominalizations.

CHAPTER FIVE

SUMMARY OF THE STUDY, SUMMARY OF FINDINGS AND RECOMMENDATIONS

5.0 Introduction

This thesis sought to investigate how nominals are derived in Dagbani, a Gur language spoken in Ghana. The current chapter brings finality into the study of some aspects of nominalization in Dagbani. In this regard, it provides summary into the discussions in the various chapters of the thesis, summarizes the findings that are drawn from the study of Dagbani nominal derivation and offers some suggestions for further studies. The theory used for the analysis in this thesis was the Basic Linguistic Theory in general and the Autosegmental Phonology as a supportive theory which basically looked at some of the phonological processes in nominalization. The chapter is grouped into four sections. Section 5.1 presents summary of the study, section 5.2 presents the summaries of the various findings made in chapter in the study. In section 5.4, the chapter offers some recommendations for future studies.

5.1 Summary of the Study

Nominalization is the process of transforming a word into a noun. The nominalized entity loses its membership in its original category and acquires or assumes membership in the nominal. For example, an adjective or a verb loses its membership in the adjectival or verbal category and acquires a nominal category. That is to say that, nominalization involves a derivational process to change the linguistic category, semantically and syntactically to noun from other word classes.

In this study, chapter one covers a background to the study, a statement of the problem for discussion, Dagbani and its speakers, purpose of the study, objectives of

the study, research questions, significance of the study as well as limitation and delimitation of the study.

Chapter two discussed some concepts of nominalization in some languages across the world. Another area discussed in this chapter is the theoretical frameworks adopted to help analyze the issues in the data properly. The researcher then adopted the Basic Linguistic theory and the Autosegmental phonology for the study. The study further examined related works in other languages including Dagbani where the phenomena of different categories assuming membership of a nominal exist. Chapter three of the study covered a detailed description of the methodology of the research. The study used existing literature drawn from both published and unpublished works in Dagbani. Another source of data was utterances drawn from my interaction with native speakers of the language including those from students, teachers of senior and basic schools. Lastly, I used my intuition as a native speaker to get some data that are relevant to this work. My native speaker's intuition therefore was one of the major sources for data for this work. In chapter four, the data collected in chapter three were then identified to turn nouns from verbs and other nouns. Whereas some of these data were found to derive action nominals, others were seen as agentive nominalization, abstract, patient nominalization, location nominalization as well as instrumental nominalization. In Dagbani different devices are employed/used in these processes. These include affixation, compounding and reduplication. The study revealed that suffixation is the most productive and predictable device in turning verb stems or roots into nouns. The study also revealed that in addition to verbal nominalization, nouns are also used to derive other nouns in Dagbani. Chapter five marks the last chapter in this study. In this chapter, I presented a conclusion on the findings

investigated after which I presented a summary of findings of the study. Finally, this chapter makes some recommendations for future research.

5.2 Summary of Findings

This study set forth to investigate some aspects of nominalization in Dagbani. The various types and processes of nominalization identified in Dagbani are comprehensively discussed in the study. The objectives of the study were to formally identify the types of nominalization in Dagbani, the morphological processes that the language employed in deriving nouns, phonological processes involved in nominalization as well as the syntactic functions of the derived nominals. Generally, the nominalization in Dagbani is primarily achieved through morphological processes of suffixation, compounding and reduplication from verbs and other nouns. The types of nominalization identified in the study were the action, abstract, agentive, patient, locative, instrument, experiencer and result/product as well as manner nominalizations. In the language, tonal pattern also plays some roles in nominalization especially, agent and patient nominalizations. These nominal suffixation triggers a high-tone tonal change in agentive and patient derived nominals. It revealed that the low-tone verb roots are usually the targets for tonal changes. Furthermore, in the case of phonological processes, some of the processes identified were; elision, epenthesis, vowel harmony, vowel lengthening and assimilation. In the study there was evidence of vowel and syllable elision in the language. As observed by some linguists, vowels are mostly elided in order to resolve hiatus, however, hiatus is not permissible in Dagbani (Nindo, 2017). The vowel and syllable elision occurred for the purposes of well-formedness in the language. These phenomena were triggered by attaching nominal suffixes to the main roots or bases.

In the study, it further revealed that syntactically, nominalized verbs can be in the subject or object position in the clause. It has been observed that generally, Dagbani seems to have a fairly rich morphological process for the derivation of nouns from verb stems and nouns and that suffixation is one of the major morphological processes for achieving this since for most cases; a suffix is attached to a stem, a derivational source. In most cases, the nominal suffixation triggers either a final vowel or consonant drop or a full syllable deletion in the derived nominal. It is also observed that the meanings of the resulting nominalized nouns are generally related to those of their corresponding verbal stems. The study also shows that compounding and reduplication are also other productive forms or processes of nominalization in Dagbani.

The action nominalization is achieved through a morphological strategy through suffixation, reduplication and inherent complement verbs by reversing the order. In the study we also discussed other types of nominalization identified in the study in which we looked at Agent nominalization, Patient nominalization, Instrument nominalization, Manner nominalization and Location nominalization among others. It revealed that unlike the Agent nominals formed through suffixation, compounding, reduplication and inherent complement verbs through suffixation and the patient nominals from compounding only, all the other types identified in the study are formed through suffixation only.

Lastly, on the basis of the study, there is evidence of the derived nominals and the prototypical Dagbani nouns having some common morphosyntactic properties. The derived nouns may occur in subject and object positions of a simple clause. In addition, it is observed that the derived nominal can take modifiers and determiners as

well as represent the possessed element in a possessive construction. Finally, it is revealed in the study that the derived nouns may be focused in ex-situ focused clause constructions.

5.3 Recommendations

No research work can ever be said to be absolute. For this reason, a lot of work can still be carried out as far as nominalization in Dagbani is concerned to unearth other issues which have not been discussed in this study. Further research can be conducted into other lexical categories like; adjectives, adverbs and non-lexical categories (clauses and phrases) in detail. Another study can be launched by looking at possible relationship between Tense, Aspect and Mood (hence TAM) marking and nominals. Finally, linguists are therefore charged to explore further on all the morphosyntactic properties of prototypical nouns in Dagbani so that enough material on it will be available. It is believed that, there are still pertinent issues and questions on nominalization yet to be employed and researched into.

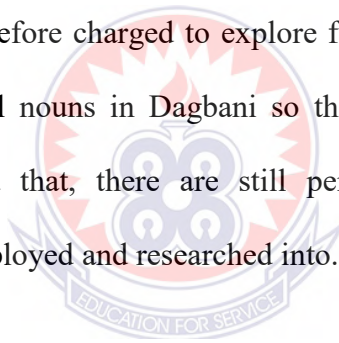

REFERENCES

- Abakah, E. N. (2004). Elision in Fante. *Africa & Asia*, 4, 181-213.
- Abdul-Rahaman, F. (2005). *A spectrographic analysis of Dagbani vowels*. (MPhil Thesis). University of Education, Winneba.
- Abdul-Rahman, F. (2013). Elision in Dagbani. *International Journal of Linguistics*, 5(1), 219-30.
- Abu-Bakari, B. (1988). *Dagbani word classes*. University of Education, Winneba.
- Adam, P. P. (2007). *Some word formation processes in Dagbani*. (MPhil Thesis). University of Education, Winneba.
- Adomako, K. (2012). Verbal nominalization as a derivational process: The case of Akan. *Ghana Journal of Linguistics* 1(2), 43-64.
- Akanlig-Pare, G. (1999), Nominal derivation in Buli. *Cahiers Voltaïques Gur Papers* 4: 99-109.
- Akrofi, A. M. (2012). Action nominalization in Lete. *Ghana Journal of Linguistics*, 1(1), 3-13.
- Anggraeni, D. (2011). *Word formation processes in outdoor advertisement: A case study of billboard installed in Semarang*. (M.A Thesis). University of Diponegoro, Semarang.
- Anindo, C. (2016). *A morphosemantics study of toponyms: Lulogooli place names*. (M.A Thesis). University of Nairobi.
- Anyanwu, O. and Omega, Ch. (2015). *Aspects of deverbal nominalization in Tee*.
- Appah, C.K.I. (2003). *Nominal derivation in Akan: A descriptive analysis*. (MPhil Thesis). Norwegian University of Science and Technology, Trondheim, Norway.
- Appah, C.K.I. (2005). *Action nominalization in Akan*. University of Ghana, Accra, Ghana.
- Asamoah, L. (2014). *A morphosyntactic analysis of some Asante habitation names (econym)*. (MPhil Thesis). University of Education, Winneba.
- Asante, R. K. (2016). *Nkami language: Description and analysis*. (Doctoral Thesis). Tongji University, Shanghai, China.
- Asante, R.K. (2018). Nominalization in Nkami. *Journal of the Linguistics Association of Nigeria*. 21(3), 99-126.

- Atipoka, A. H. and Nsoh, A. E. (2018). Vowel harmony in Gurene. *Ghana Journal of Linguistics* 7(2), 102-133.
- Badan, Linda. (2012). Obligatory Complement Verbs in Mandarin and Ewe. *The Fifth International Workshop on Weak Referentiality*, Utrecht University.
- Bisilki, A.K. (2019). Posture verb nominalization in Likpakpaln (Konkomba). *Ghana Journal of Linguistics*. 8(1), 1-22.
- Bodomo, A. B. (1997). *The structure of Dagaare*. Stanford monographs in African languages. Stanford: CSLI Publications.
- Bomanchihi, V. N. (2012). *Some word formation processes in Dagaare*. (MPhil Thesis). University of Education, Winneba.
- Bresnan, J. & J. Mugane. (2006). *Agentive nominalizations in Gikuyu and the theory of mixed categories*. In R.M. Kaplan, M. Butt, M. Dalrymple & T.H. King (Eds.), *Intelligent Linguistic Architectures: Variations on Themes*, 201-234. Stanford, California: CSLI Publications.
- Chomsky, N. (1970). *Remarks on nominalization*. In R. Jacobs & P.S. Rosenbaum (Eds.), *Readings in English Transformational Grammar*, 184-221. Boston: Gin.
- Comrie, B. & S.A. Thompson. (1985). *Lexical nominalization*. In T. Shopen (Ed.), *Language Typology and Syntactic Description*. Vol. 3:349-398. Cambridge: Cambridge University Press.
- Crystal, D. (1991). *A dictionary of linguistics and phonetics*. 3rd edition. Oxford, UK: Blackwell.
- Dagbani Orthography Committee. (1999). *Approved Dagbani orthography*. Tamale.
- Dakubu, M.E.K. (2005). *Collected notes on Dagaare grammar*. Legon: Institute of African studies.
- Dixon, R. M.W. (2009). *Basic linguistic theory. Methodology. Vol. I*. Oxford, UK: Oxford University Press.
- Dixon, R. M.W. (2010). *Basic linguistic theory. Vols. I II, III*. Oxford, UK: Oxford University Press.
- Dixon, R. M.W. (2012). *Basic linguistic theory. Further grammatical topics. Vol. III*. Oxford, UK: Oxford University Press.
- Djaki, C. G. (2001). *Nominalization strategies in Bete*. (M.A Thesis). Nairobi Evangelical Graduate School of Theology.

- Dryer, M. S. (2006). *Descriptive theories, explanatory theories, and basic linguistic theory*. In F. Ameka, A. Dench, & N. Evans (Eds.). *Catching language: issues in grammar writing*, 207-234. Berlin: Mouton de Gruyter.
- Dörnyei, Z. (2007). *Research methods in Applied Linguistics: Quantitative, qualitative, and mixed methodologies*. Oxford: Oxford University Press.
- Fatawu, A. (2018). *A morphosyntactic study of personal proverbial names in Mampruli*. (MPhil Thesis). University of Education, Winneba.
- Galucio, A. V. (2011). *Massachusetts Institute of Technology*. Museu Paraense Emílio Goeldi.
- Ghana Statistical Service (2010). *Populations and Housing Census: Summary Report of Final Results*, Accra: Ghana Statistical Service.
- Goldsmith, J. A. (1976b). *Autosegmental Phonology*. (Doctoral Thesis). MIT
- Gurundoo, J. M. (2012). *Investigating the morphosyntactic features of the Dagbani verbal phrase*. (MPhil Thesis). University of Education, Winneba.
- Hakore, D. (1998). *Nominalization in Hadiyya*. (M.A Thesis). Nairobi Evangelical Graduate School of Theology.
- Hudu, F. (2010). *Dagbani Tongue-root Harmony: A Formal Account with Ultrasound Investigation*. (Doctoral Thesis). University of British Columbia.
- Issah, S. A. (2011). The phonology of Dagbani verbal reduplication. *Journal of West African Languages*, XXXVIII.1, 40-52.
- Khadi, T. (2014). *Clausal nominalization in Wolf*. (Doctoral Thesis). University of Kansas.
- Leonard, L. K. (2000). *The derivational morphology of the Maa noun*. (M.A Thesis). Nairobi Evangelical Graduate School of Theology.
- Lois, M.W. (2005). *Nominalization structure in Kikuyu*. (M.A Thesis). Nairobi Evangelical Graduate School of Theology.
- Mahama, I. (2004). *History and tradition of Dagbon*. Tamale, Ghana: GILLBT Press.
- Mahama, I. (2010). *English- Dagbani Dictionary*. Tamale, Ghana: GILLBT Press.
- Matanda, E. (2004). *Nominalization in Chechewa*. (M.A Thesis). Nairobi Evangelical Graduate School of Theology.
- Mathews, P. H. (2005). *Oxford concise dictionary of linguistics*. Oxford: Oxford University Press.

- Naden, A. (1989). Gur. In J. Bendor-Samuel (Ed.). *The Niger-Congo languages: A classification and description of Africa's largest language family*, 141-168. Lanham, MD: University Press of America.
- Nwachukwu, P.A. (1985). Inherent complement verbs in Igbo. *Journal of Linguistic Association of Nigeria*. 3, 61-74.
- Nwachukwu, P.A. (1987). *Argument structure of Igbo verbs*. Lexicon Project. Cognitive Science Center: MIT Press.
- Naden, T. (1988). The Gur Languages. In M. E. K. Dakubu (Ed.). *The languages of Ghana*, 12-49. London. UK: Kegan Paul.
- Nindoo, M. O. (2018). *Some syllable structure processes in Dagbani: An Optimality Theory Account*. (MPhil thesis). University of Education, Winneba.
- Ochieng, A. L. (2013). *A description of the morphosyntactic structure of the Suba language*. (M.A Thesis). Egerton University, Nakuru, Kenya.
- Ofori, G. K. (1988). *Nominalization in Ewe (The process)*. (M.A Thesis). University of Ghana.
- Ofori, K. (2014) *A grammar of Anum*. (Doctoral Thesis). University of Education, Winneba.
- Olawsky, J. K. (1999). *Aspects of Dagbani grammar: with special emphasis on phonology and morphology*. (Doctoral Thesis). Lincom.
- Oppong, C. (1973). *Growing up in Dagbañ*. Tema: Ghana Publishing Cooperation.
- Payne, T. (1997). *Describing morphosyntax: A guide for field linguists*. Cambridge, UK: Cambridge
- Roger, B. (2004). *Dagbani-English dictionary*. Retrieved 12/12/2018
- S. K. (1998) *Nominal constructions in Akan*. (MPhil Thesis). Norwegian University of Science and Technology, Trondheim, Norway.
- Saul, A. K. (1972). Naming and necessity. *Semantics of natural language*, 253-355.
- Thakur, D. (2010). *Linguistics Simplified: Morphology*. New Delhi, India: Bharati Bhawan Publishers. University Press.
- Wilson, W. A. A. (1972). *An introductory course on Dagbani*. Tamale, Ghana: Ghana Institute of Linguistic, Literacy and Bible Translation.
- Wilson, W. A. A. and Bendor-Samuel, J. T. (1969). *The phonology of the nominal in Dagbani*. *Linguistics*. 5(2), 56-82.

Yegbe, K. A. (2000). *Processes of nominalization in Mwan*. (M.A Thesis). Nairobi Evangelical Graduate School of Theology.

Ziblim, Y. (2018). *Morphosyntax of Dagbani nominal phrase*. (MPhil thesis). University of Education, Winneba.



APPENDIX

SOME NOMINALIZED FORMS IN DAGBANI

S/N	NOMINALS	ENGLISH GLOSS
1	kpibu	'death/dying'
2	ɲarili	'cheating'
3	ɲariliɲarili	'cheating'
4	zabili	'fight/fighting'
5	zabilizabili	'fighting'
6	nyɔbu	'burning'
7	nyɔbunɔbu	'burning'
8	chomda	'saboteur'
9	kpibukpibu	'death/dying'
10	dabu	'buying'
11	dabudabu	'buying'
12	chandi	'walking'
13	chandichandi	'walking'
14	zubu	'stealing'
15	zubuzubu	'stealing/theft'
16	maligo	'performance'
17	layingo	'meeting/congregation'
18	vihigu	'investigation/research'
19	lirigo	'attack'
20	baɲda	'a knowledgeable person'
21	namda	'creator'

22	soŋda	‘helper/supporter’
23	daarodaaro	‘one who pushes things’
24	nyaronyaro	‘seer’
25	tiro tiro	‘giver’
26	kperigu	‘acting’
27	kperikperita	‘an actor/actress’
28	wawara	‘a dancer’
29	sheshera	‘a seamstress/ tailor’
30	zazabira	‘a fighter’
31	sasabira	‘a writer’
32	paana	‘one who fulfils promises’
33	yoona	‘caretaker/ guardian’
34	maana	‘one who repairs/a repairer’
35	dara	‘buyer’
36	nyahira	‘taster’ (one who tastes food)
37	shera	‘one who sews’
38	sahira	‘one who sharpens’
39	chandochando	‘one who walks aimlessly’
40	nyihironyihiro	‘being inquisitive/spy’
41	tira	‘giver’
42	daara	‘pusher/ one pushes things’
43	chanda	‘walker/someone who walks’
44	lihira	‘viewer’
45	wumda	‘listener’

46	wuhira	'one who directs/teacher'
47	kulipala	'fisherman'
48	biyola	'babysitter'
49	nakōha	'a butcher/someone who sells meat'
50	sochanda	'traveler'
51	naydara	'buyer (of) cattle'
52	warbara	'horse rider'
53	daabia	'a trader'
54	karimbia	'a student/learner'
55	karimba	'a teacher'
56	zahinda	'a dreamer'
57	bōhinda	'learner'
58	dooshee	'a place for sleeping'
59	sahibushee	'a place used for sharpening of the things'
60	dibushee	'a place used for eating'
61	malibushee	'a place used for repairing'
62	waribarili	' a horse used for riding'
63	nyudarili	'yam for sale'
64	nimsherili	'roasted meat'
65	dirigu	'spoon'
66	terigu	'sieve'
67	sahigu	'sharpener'
68	sheriga	'needle'

69	zaliḡu	‘law/command’
70	kperigu	‘a play/ drama’
71	yeliḡu	‘speech’
72	sabbu	‘writing (way of) writing / handwriting’
73	yilli	‘song’
74	waa	‘dance’
75	piliḡu	‘beginning’
76	gbeliḡu	‘stare’
77	lari	‘laughter/laugh’
78	duyili	‘manner (way of) cooking’
79	zaa	‘manner (way of) standing’
80	dibu	‘manner (way of) eating’
81	chandi	‘way (manner) of walking’
82	viɛɪm	‘beauty’
83	balim	‘smoothness/softness’
84	sabilim	‘blackness’
85	pɛɪɪm	‘whiteness/whitish’
86	wayɪɪm	‘length/ height’
87	choyinsi	‘being weak/weakness’
88	moosim	‘being red/redness’
89	nyom	‘smell/scent’
90	tom	‘bitterness’
91	niriliḡu	‘kindness’

92	yurilim	'love'
93	bilim	'childishness'
94	bidiblim	'youthful/boyish exuberance'
95	jeritali	'foolishness'
96	ninsalitali	'humanity'

